



# welters

## ORGANISATION WORLDWIDE

DESIGN AND MANAGEMENT CONSULTANTS  
RESEARCH, DEVELOPMENT AND  
MANUFACTURING

P.O. Box 159 Carlisle, Great Britain CA2 5BG

Sales: +44(0)8702 418240 (national rate)

Admin: +44(0)8702 416422 (national rate)

Fax: +44(0)1228 674959

E-mail: sales@welters-worldwide.com

## Memorial and Interment Specialists

[welters-worldwide.com](http://welters-worldwide.com)

**welters** are the pioneers of safe systems innovation, designing and installing safe alternatives for interment and memorial provision. Shown here are a small selection of our products for cemetery and crematoria services.



Granite & Stone Sculptures



Interior Niche Structures



Portico of Peace



Cremated Remains Interment

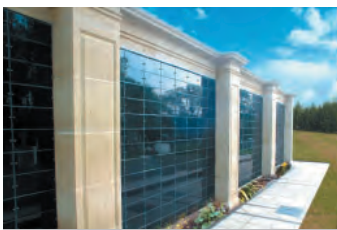

Large Niche Structures



DESIGN



MANUFACTURE



Granite-clad Chambers



Interior Oak Niche Repositoria



INSTALL

Cemetery Architecture - Cremated Remains Interment Memorial Garden

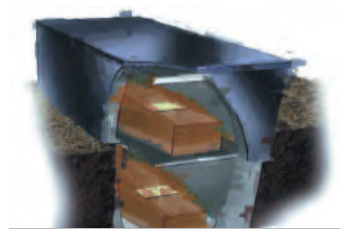

Double Depth Chambers



Muslim Burial Chambers



Shallow Grave Extension System



Safe Memorial Systems



Burial Chamber Memorials



Family Mausolea with Ashes Interment



Granite Mausolea



Stone Mausolea



Architectural Design Services

**Complete project management and support services. Design-Supply-Installation**

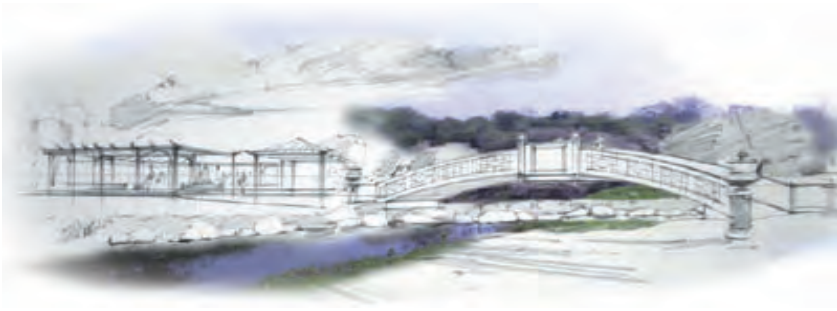

# welters

## ORGANISATION WORLDWIDE

DESIGN AND MANAGEMENT CONSULTANTS  
RESEARCH, DEVELOPMENT AND  
MANUFACTURING

P.O. Box 159 Carlisle, Great Britain CA2 5BG

Sales: +44(0)8702 418240 (national rate)

Admin: +44(0)8702 416422 (national rate)

Fax: +44(0)1228 674959

E-mail: [sales@welters-worldwide.com](mailto:sales@welters-worldwide.com)

Web: [www.welters-worldwide.com](http://www.welters-worldwide.com)

## Cemetery Architectural Services

## Memorial and Interment Specialists

**welters** are the pioneers of safe systems innovation, designing and installing safe alternatives for interment and memorial provision. Shown here are a small selection of our products for cemetery and crematoria services.



Family Mausolea with Ashes Interment



Granite Mausolea



Stone Mausolea



Architectural Design Services



Interior Oak Niche Repositoria



Cemetery Architecture - Cremated Remains Interment Memorial Garden

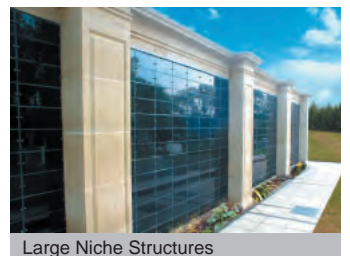

Large Niche Structures

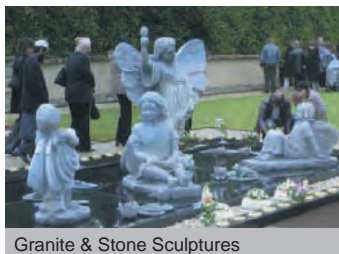

Granite & Stone Sculptures



Maintenance Free Space Saving Cemetery Village<sup>®</sup> Schemes



Interior Niche Structures



Muslim Burial Chambers

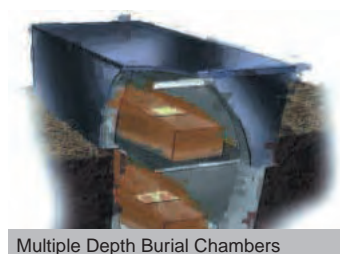

Multiple Depth Burial Chambers



Shallow Grave Extension System

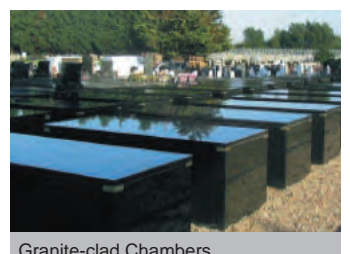

Granite-clad Chambers



Below Ground Cremated Remains



Memorial Kerbs



Above Ground Cremated Remains



Safe Burial Chamber Memorials

**New and Existing Cemetery Design and Build Packages. Consultation and Professional Services.**

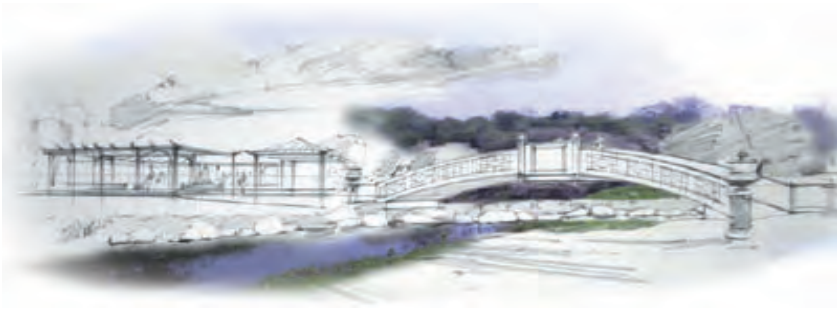

# welters

## ORGANISATION WORLDWIDE

DESIGN AND MANAGEMENT CONSULTANTS  
RESEARCH, DEVELOPMENT AND  
MANUFACTURING

P.O. Box 159 Carlisle, Great Britain CA2 5BG

Sales: +44(0)8702 418240 (national rate)

Admin: +44(0)8702 416422 (national rate)

Fax: +44(0)1228 674959

E-mail: [sales@welters-worldwide.com](mailto:sales@welters-worldwide.com)

Web: [www.welters-worldwide.com](http://www.welters-worldwide.com)

## Cemetery Architectural Services

## Memorial and Interment Specialists

**welters** are the pioneers of safe systems innovation, designing and installing safe alternatives for interment and memorial provision. Shown here are a small selection of our products for cemetery and crematoria services.



Family Mausolea with Ashes Interment



Side Charging Mausolea

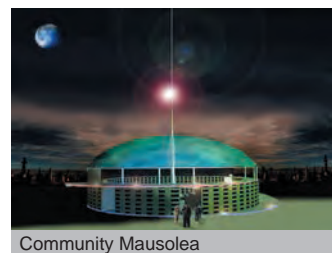

Community Mausolea



Architectural Design Services



Interior Niche Structures



Cemetery Architecture - Cremated Remains Interment Memorial Garden

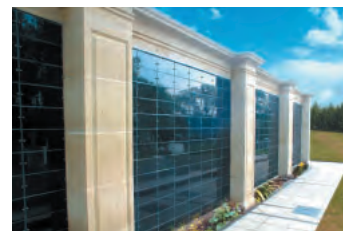

Large Niche Structures

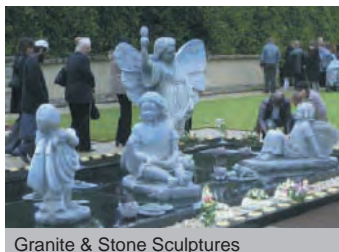

Granite & Stone Sculptures



Maintenance Free Space Saving Cemetery Village<sup>©</sup> Schemes

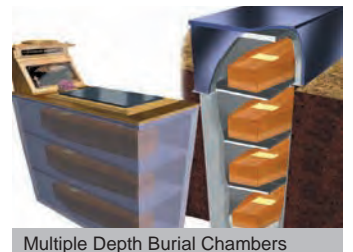

Multiple Depth Burial Chambers

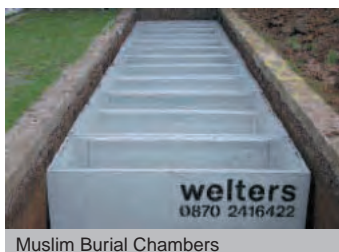

Muslim Burial Chambers



Granite-clad Chambers



Safe Burial Chamber Memorials



Below Ground Cremated Remains



Memorial Kerbs



Above Ground Cremated Remains



Safe Burial Chamber Memorials

**New and Existing Cemetery Design and Build Packages. Consultation and Professional Services.**



# welters

## ORGANISATION WORLDWIDE

DESIGN AND MANAGEMENT CONSULTANTS  
RESEARCH, DEVELOPMENT AND  
MANUFACTURING

P.O. Box 159 Carlisle, Great Britain CA2 5BG

Sales: +44(0)8702 418240 (national rate)

Admin: +44(0)8702 416422 (national rate)

Fax: +44(0)1228 674959

E-mail: [sales@welters-worldwide.com](mailto:sales@welters-worldwide.com)

Web: [www.welters-worldwide.com](http://www.welters-worldwide.com)

## welters Cemetery Village<sup>©</sup>

# The Ultimate Funeral Experience



**welters** invite Funeral Directors to discuss arrangements for administration partnerships, pre purchase, purchase in reserve and payment management.



Coming to a Local Authority near you. Phone Keith Welters direct on 07710 109 457

# welters Cemetery Village®



**New Concepts -  
Traditional Values**

Memorial and Interment Specialists  
All enquiries and assistance telephone 08702 416 422

[welters-worldwide.com](http://welters-worldwide.com)



# welters

ORGANISATION  
WORLDWIDE

welters Cemetery Village<sup>©</sup>

The Ultimate Funeral Experience



**Mausolea - Burial Chambers  
Cremation Interment Facilities**  
[www.welters-worldwide.com](http://www.welters-worldwide.com)



Coming to a Local Authority near you. Phone our National UK no. 08702 416 422



# welters

## ORGANISATION WORLDWIDE

DESIGN AND MANAGEMENT CONSULTANTS  
RESEARCH, DEVELOPMENT AND  
MANUFACTURING

P.O. Box 159 Carlisle, Great Britain CA2 5BG  
Sales: +44(0)8702 418240 (national rate)  
Admin: +44(0)8702 416422 (national rate)  
Fax: +44(0)1228 674959  
E-mail: [sales@welters-worldwide.com](mailto:sales@welters-worldwide.com)  
Web: [www.welters-worldwide.com](http://www.welters-worldwide.com)

## Cemetery Architectural Services

## Memorial and Interment Specialists

**welters** are the pioneers of safe systems innovation, designing and installing safe alternatives for interment and memorial provision. We specialise in creating Cemetery Extension Solutions within existing cemeteries, providing clean, dry and safe burial sections whilst solving re-use and problematic land issues. Shown below are a small selection of our products and services.



Family Mausolea with Ashes Interment

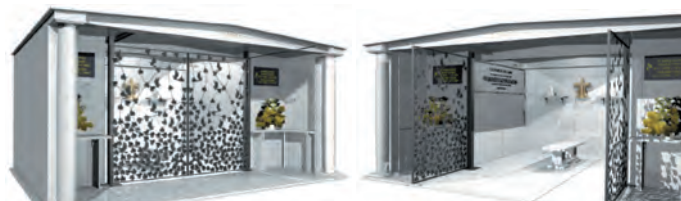

The Tiber Mausoleum



Architectural Design Services

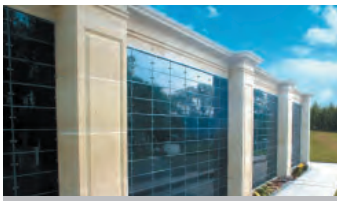

Large Niche Structures



Side Charging Mausolea



Decorative Stone Products



Landscape Furniture



Maintenance Free Space Saving Cemetery Village<sup>®</sup> Schemes



Muslim Burial Chambers



Cemetery Architecture - Cremated Remains Interment Memorial Garden



Granite-clad Chambers



Multiple Depth Burial Chambers



Above Ground Cremated Remains



Safe Burial Chamber Memorials

**New and Existing Cemetery Design and Build Schemes. Partnership and Financial Packages available.**

# Lambeth and Streatham Cemeteries



## New Landmark Cemetery Village<sup>®</sup> Schemes

Premier above ground mausolea and below ground burial chamber, multi-denominational interment with inclusive memorial options at an affordable price for all.



Side Charging Mausolea



Seating



Tablet Inscription and Ornaments



Double Depth Burial Chambers



Decorative Stone Memorials



Decorative Arch Way



The Ultimate Funeral Experience



Entrance Incorporating Cremated Remains Niche Facilities



Planters

**welters**  
ORGANISATION  
WORLDWIDE

In association with

Contact Lambeth Cemetery Office for prices and lease term information on 0208 672 6342



# Lambeth and Streatham Cemeteries



## New Landmark Cemetery Village<sup>®</sup> Schemes

Premier above ground mausoleum and below ground burial chambers, facilitating full casket multi-denominational interment with inclusive memorial options at affordable prices for all.



*Side Charging Mausolea*



*Seating*

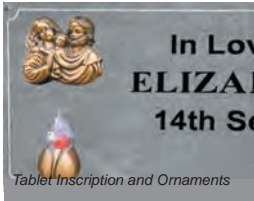

*Tablet Inscription and Ornaments*



*Double Depth Burial Chambers*



*Decorative Stone Memorials*



*Decorative Arch Way*



*The Ultimate Funeral Experience*



*Entrance Incorporating Cremated Remains Niche Facilities*



*Planters*

**welters**  
ORGANISATION  
WORLDWIDE

In association with

Contact Lambeth Cemetery Office and ask for details on introductory offer prices now with pre purchase options and lease term information on 0208 672 6342



# welters

ORGANISATION  
WORLDWIDE

welters Cemetery Village<sup>©</sup>

**The Ultimate Funeral Experience**

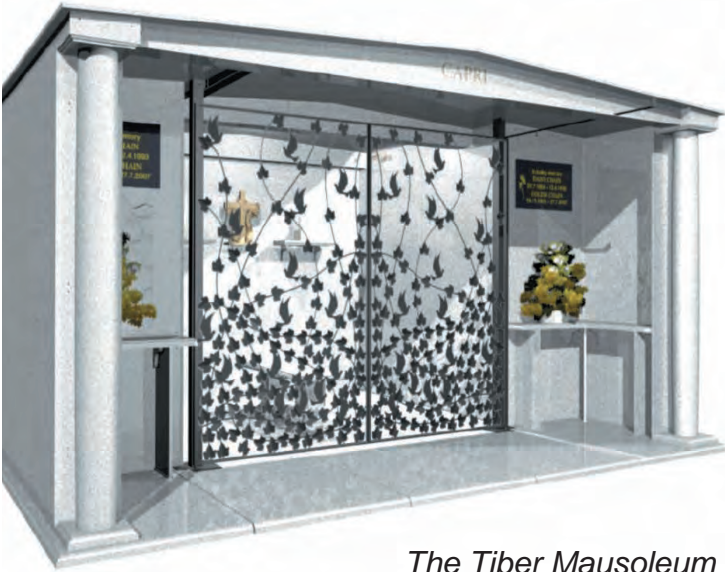

*The Tiber Mausoleum*



*Tablet Inscription and Ornaments*

**Mausolea - Burial Chambers - Cremation Interment Facilities**

**[www.welters-worldwide.com](http://www.welters-worldwide.com)**



**Coming to a Local Authority near you. Enquire about discounted trade pre-purchase options - 08702 416 422**



# welters

ORGANISATION  
WORLDWIDE

welters Cemetery Village<sup>©</sup>

The Ultimate Funeral Experience

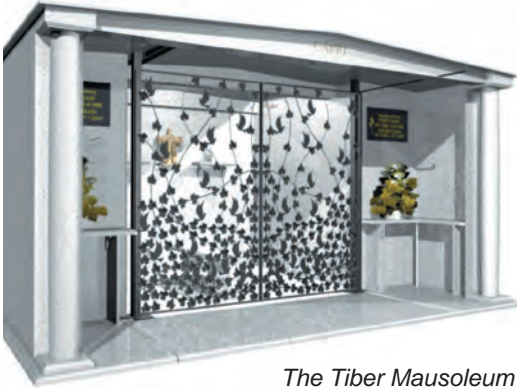

*The Tiber Mausoleum*



*Tablet Inscription and Ornaments*

**Mausolea - Burial Chambers - Cremation Interment Facilities**

**[www.welters-worldwide.com](http://www.welters-worldwide.com)**



**Coming to a Local Authority near you. Enquire about discounted trade pre-purchase options - 08702 416 422**

# Lambeth and Streatham Cemeteries



## New Landmark Cemetery Village<sup>®</sup> Schemes

Premier above ground mausoleum and below ground burial chambers, facilitating full casket multi-denominational interment with inclusive memorial options at affordable prices for all.



Side Charging Mausolea



Seating

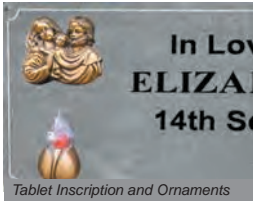

Tablet Inscription and Ornaments



Double Depth Burial Chambers



Decorative Stone Memorials



Decorative Arch Way



The Ultimate Funeral Experience



Entrance Incorporating Cremated Remains Niche Facilities



Planters

**welters**  
ORGANISATION  
WORLDWIDE

In association with

Contact Lambeth Cemetery Office and ask for details on introductory offer prices now with pre purchase options and lease term information on 0208 672 6342



**welters**  
ORGANISATION  
WORLDWIDE

## Architectural Services

# Memorial and Interment Specialists

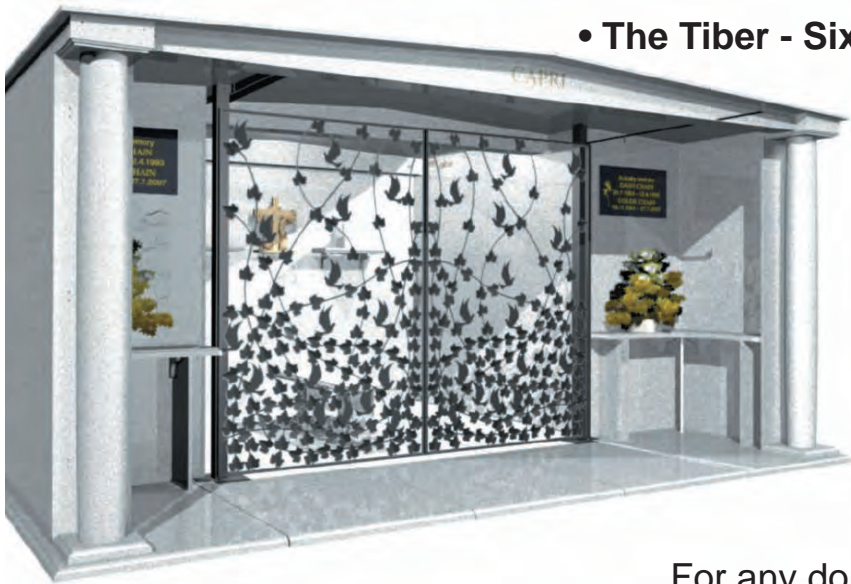

• **The Tiber - Six interment Family Chapel Mausoleum**

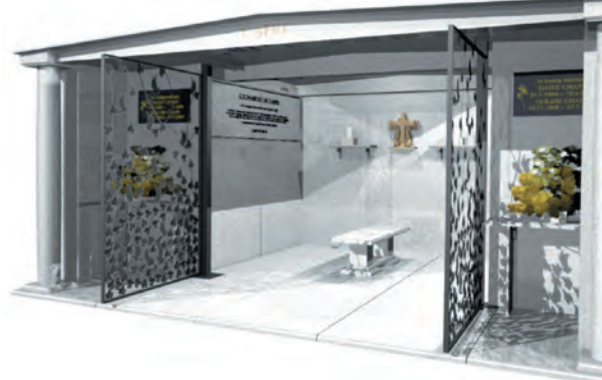

- Prices from £40k fully installed •
- Any material and specification •
- For any domestic residence or family estate •

- 'Bespoke' specialist architectural design and install or
- 'From the shelf' supply and install service

- For private residence or
- Within an existing cemetery or crematoria

- Burial Chambers from £5k double interment fully installed plus



- **Four interment Family Midi Mausoleum**
- Prices from £14k fully installed

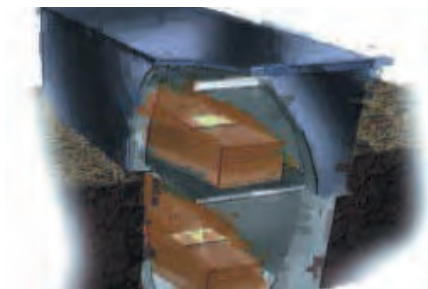

- Above and below ground Burial Chambers and Cremated Remains Interment

**Call 08702 418 240 for a free survey and proposal**

# welters Cemetery Village<sup>©</sup>

## The Ultimate Funeral Experience

# welters

ORGANISATION  
WORLDWIDE

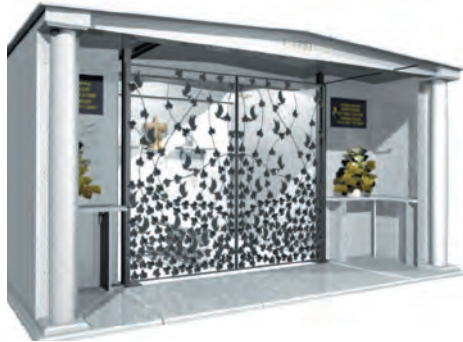

*The Tiber and Midi Mausolea*



**Mausolea  
Burial Chambers  
Cremation Interment Facilities**  
[www.welters-worldwide.com](http://www.welters-worldwide.com)



*Express Tablet Inscription Service*



Coming to a Cemetery and Crematorium near you. Enquire about discounted trade pre-purchase options - 08702 416 422



# welters

ORGANISATION  
WORLDWIDE

## welters Cemetery Village<sup>©</sup>

# The Ultimate Funeral Experience



*The Tiber Mausoleum*



*Express Tablet Inscription Service*

**Mausolea - Burial Chambers - Cremation Interment Facilities**

**[www.welters-worldwide.com](http://www.welters-worldwide.com)**

**Visit our website to view the complete range of interment systems available.**



**Coming to a Cemetery and Crematorium near you. Enquire about discounted trade pre-purchase options - 08702 416 422**

# Brockley Cemetery



Lewisham

## New Burial Chamber Scheme Now Available

Premier below ground double interment burial chambers with safe memorial systems.



Entrance



Decorative Stone Memorials



450 Basilica Memorial System



Express Tablet Inscription Service



Classic 900 Memorial System



Double depth below ground burial chambers with memorial systems



The Ultimate Funeral Experience



Planters and seating

welters  
ORGANISATION  
WORLDWIDE

In association with

Contact Lewisham Crematorium and ask for details on introductory offer prices now with pre purchase options and lease term information on 0181 697 3260



# Willesden New Cemetery



New Burial Chamber Scheme now available at Willesden New Cemetery, Franklyn Road, Willesden



Double interment below ground Burial Chambers with Classic Memorial Systems



Decorative Stone Memorials



Triple interment Burial Chambers. Top interment above ground level and clad in granite.



Express Tablet Inscription Service



Double Interment Burial Systems

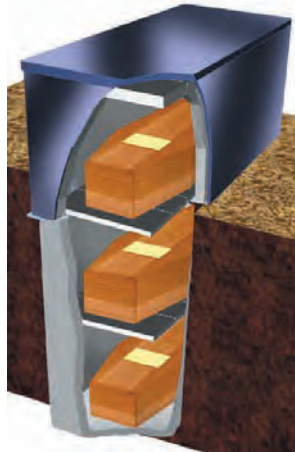

Triple Interment Burial Systems



The Ultimate Funeral Experience

In association with

**welters**  
ORGANISATION  
WORLDWIDE

For additional information, contact Brent Borough Council Cemeteries Office on 0208 902 2385

# Wellingborough Cemeteries



New Burial Chamber Schemes and Mausolea  
Now Available at Doddington Road and Wollaston Cemeteries



Back to back Decorative Stone Mausolea



Decorative Stone Memorials



Traditional Section



Double Interment Burial Systems



Cremated Remains below ground vaults



Express Tablet Inscription Service



The Ultimate Funeral Experience

Contact

and ask for details on introductory offer prices now with pre purchase options and lease term information on

In association with

**welters**  
ORGANISATION  
WORLDWIDE



# welters

## ORGANISATION WORLDWIDE

DESIGN AND MANAGEMENT CONSULTANTS  
RESEARCH, DEVELOPMENT AND  
MANUFACTURING

P.O. Box 159 Carlisle, Great Britain CA2 5BG

Sales: +44(0)8702 418240 (national rate)

Admin: +44(0)8702 416422 (national rate)

Fax: +44(0)1228 674959

E-mail: [sales@welters-worldwide.com](mailto:sales@welters-worldwide.com)

Web: [www.welters-worldwide.com](http://www.welters-worldwide.com)

## welters Cemetery Village<sup>©</sup>

### The Ultimate Funeral Experience

Inspired Products and Services



**Have you had problems with water or a lack of space in your cemetery? Or do you simply require a full design and build service for a beautiful and functional burial and cremation facility?**

Design driven schemes with **cost effective fixed unit price fully installed** above and below ground multi denominational burial chamber solutions, including memorialisation, for any location. Facilitating pre selling with **zero environmental impact** and no additional drainage requirements giving clean, dry, safe enhanced service provision options in any location without disturbing existing remains and **no, or low ongoing maintenance cost burden to the tax payer.**



Burial Chamber Installation in saturated land

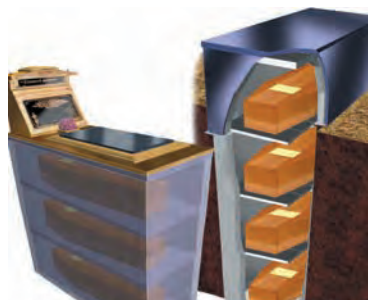

Multiple interment Chambers - from £500 per interment fully installed



Cremated Remains Interment



From £1500 per double chamber fully installed including memorial



Cremated Remains Features - from £80 per interment fully installed

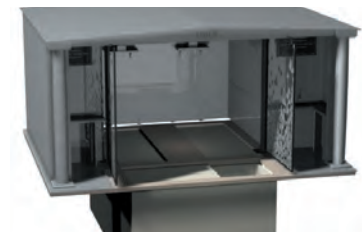

12 interment Vaulted Tiber Mausoleum - from £50k fully installed

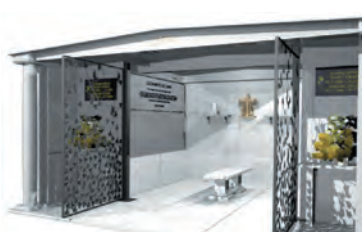

6 interment Tiber Mausoleum - from £40k fully installed



Midi Mausoleum - from £10k fully installed



Tranquil Cemetery Village<sup>©</sup> Island of Peace and Reflection



Courtyard Niche Developments - from £80 per interment fully installed

Call now for a free survey before you waste any money on expensive non specialist architects, high maintenance non revenue generating infrastructure and ineffective alternatives. Please ask for details of our comprehensive 'conception to completion' service including full marketing, maintenance and express inscription support services.

All prices shown are excluding VAT

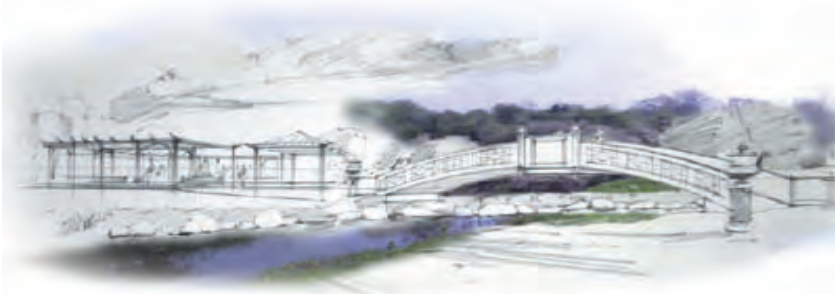

# welters

## ORGANISATION WORLDWIDE

DESIGN AND MANAGEMENT CONSULTANTS  
RESEARCH, DEVELOPMENT AND  
MANUFACTURING

P.O. Box 159 Carlisle, Great Britain CA2 5BG  
Sales: +44(0)8702 418240 (national rate)  
Admin: +44(0)8702 416422 (national rate)  
Fax: +44(0)1228 674959  
E-mail: [sales@welters-worldwide.com](mailto:sales@welters-worldwide.com)  
Web: [www.welters-worldwide.com](http://www.welters-worldwide.com)

## Cemetery Architectural Services

## Memorial and Interment Specialists



**welters** are the pioneers of safe systems innovation, designing and installing safe alternatives for interment and memorial provision. Shown here are a small selection of our products for cemetery and crematoria services.



Family Mausolea with Ashes Interment



Side Charging Mausolea

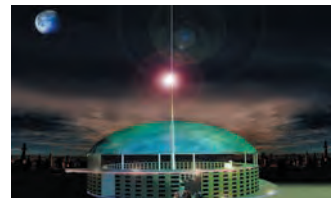

Community Mausolea



Architectural Design Services



Interior Niche Structures



Cemetery Architecture - Cremated Remains Interment Memorial Garden



Large Niche Structures



Granite & Stone Sculptures



Maintenance Free Space Saving Cemetery Village Schemes

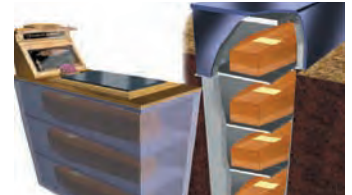

Multiple Depth Burial Chambers



Muslim Burial Chambers



Maintenance Free Space Saving Cemetery Village Schemes



Granite-clad Chambers



Below Ground Cremated Remains



Memorial Kerbs



Above Ground Cremated Remains



Safe Burial Chamber Memorials

**New and Existing Cemetery Design and Build Packages. Consultation and Professional Services.**



# welters

## ORGANISATION WORLDWIDE

DESIGN AND MANAGEMENT CONSULTANTS  
RESEARCH, DEVELOPMENT AND  
MANUFACTURING

P.O. Box 159 Carlisle, Great Britain CA2 5BG  
Sales: +44(0)8702 418240 (national rate)  
Admin: +44(0)8702 416422 (national rate)  
Fax: +44(0)1228 674959  
E-mail: sales@welters-worldwide.com  
Web: www.welters-worldwide.com

## welters Cemetery Village<sup>©</sup>

### The Ultimate Funeral Experience

Inspired Products and Services



**Have you had problems with water or a lack of space in your cemetery? Or do you simply require a full design and build service for a beautiful and functional burial and cremation facility?**

Design driven schemes with **cost effective fixed unit price fully installed** above and below ground multi cultural burial chamber solutions, including memorialisation, for any location. Facilitating pre selling with **zero environmental impact** and no additional drainage requirements giving clean, dry, safe enhanced service provision options in any location without disturbing existing remains and **no, or low ongoing maintenance cost burden to the tax payer.**



Burial Chamber Installation in saturated land

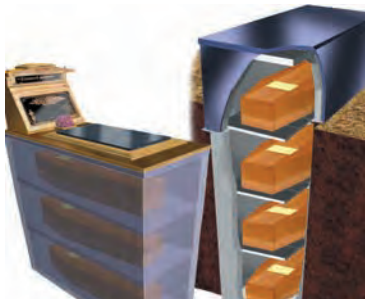

Multiple interment Chambers - from £500 per interment fully installed



Support and Inscription Services



From £1500 per double chamber fully installed including memorial



Cremated Remains Features - from £80 per interment fully installed



6 interment Tiber Mausoleum - from £40k fully installed



Midi Mausoleum - from £10k fully installed



Tranquil Cemetery Village<sup>©</sup> Island of Peace and Reflection



Interment Support Services



Solar powered Tree of Life Fountain -

Call now for a free survey before you waste any money on expensive non specialist architects, high maintenance non revenue generating infrastructure and ineffective alternatives. Please ask for details of our comprehensive 'conception to completion' service including full marketing, maintenance and express inscription support services.

All prices shown are excluding VAT



# welters

## ORGANISATION WORLDWIDE

DESIGN AND MANAGEMENT CONSULTANTS  
RESEARCH, DEVELOPMENT AND  
MANUFACTURING

P.O. Box 159 Carlisle, Great Britain CA2 5BG  
Sales: +44(0)8702 418240 (national rate)  
Admin: +44(0)8702 416422 (national rate)  
Fax: +44(0)1228 674959  
E-mail: sales@welters-worldwide.com  
Web: www.welters-worldwide.com

## welters Cemetery Village<sup>©</sup>

### The Ultimate Funeral Experience

Inspired Products and Services



**Have you had problems with water or a lack of space in your cemetery? Or do you simply require a full design and build service for a beautiful and functional burial and cremation facility?**

Design driven schemes with **cost effective fixed unit price fully installed** above and below ground multi cultural burial chamber solutions, including memorialisation, for any location. Facilitating pre selling with **zero environmental impact** and no additional drainage requirements giving clean, dry, safe enhanced service provision options in any location without disturbing existing remains and **no, or low ongoing maintenance cost burden to the tax payer.**



Burial Chamber Installation in saturated land

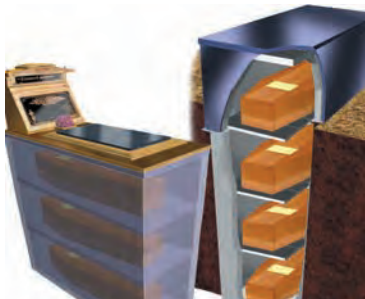

Multiple interment Chambers - from £500 per interment fully installed



Support and Inscription Services



From £1500 per double chamber fully installed including memorial



Cremated Remains Features - from £80 per interment fully installed



6 interment Tiber Mausoleum - from £40k fully installed



Midi Mausoleum - from £10k fully installed



Tranquil Cemetery Village<sup>©</sup> Island of Peace and Reflection



Interment Support Services



Solar powered Tree of Life Fountain -

Call now for a free survey before you waste any money on expensive non specialist architects, high maintenance non revenue generating infrastructure and ineffective alternatives. Please ask for details of our comprehensive 'conception to completion' service including full marketing, maintenance and express inscription support services.

All prices shown are excluding VAT

# Lambeth and Streatham Cemeteries



## New Landmark Cemetery Village<sup>©</sup> Schemes

Premier above ground mausoleum and below ground chambers, facilitating full casket multi-denominational interment with inclusive memorial options at affordable prices for all.



Side Charging Mausolea - black granite and colour options are available for the front tablets when the tablets are inscribed



Seating

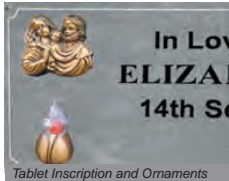

Tablet Inscription and Ornaments



Double Depth Burial Chambers



Decorative Stone Memorials

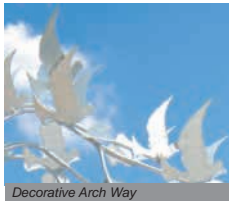

Decorative Arch Way



The Ultimate Funeral Experience



Entrance Incorporating Cremated Remains Niche Facilities



Planters

**welters**  
ORGANISATION  
WORLDWIDE

In association with

Contact Lambeth Cemetery Office and ask for details on introductory offer prices now with pre purchase options and lease term information on 0208 672 6342

# Wellingborough Cemeteries



New Burial Chamber Schemes and Mausolea  
Now Available at Doddington Road and Wollaston Cemeteries



Back to back Decorative Stone Mausolea with large black granite tablets



Decorative Stone Memorials



Traditional Section



Double Interment Burial Systems



Cremated Remains below ground vaults



Express Tablet Inscription Service



The Ultimate Funeral Experience

Contact

and ask for details on introductory offer prices now with pre purchase options and lease term information on

In association with  
**welters**  
ORGANISATION  
WORLDWIDE





# welters

## ORGANISATION WORLDWIDE

DESIGN AND MANAGEMENT CONSULTANTS  
RESEARCH, DEVELOPMENT AND  
MANUFACTURING

P.O. Box 159 Carlisle, Great Britain CA2 5BG  
Sales: +44(0)8702 418240 (national rate)  
Admin: +44(0)8702 416422 (national rate)  
Fax: +44(0)1228 674959  
E-mail: [sales@welters-worldwide.com](mailto:sales@welters-worldwide.com)  
Web: [www.welters-worldwide.com](http://www.welters-worldwide.com)

## welters Cemetery Village<sup>©</sup>

### The Ultimate Funeral Experience

### Inspired Products and Services

**Have you had problems with water or a lack of space in your cemetery?** Or do you simply require a full design and build service for a beautiful and functional burial and cremation facility?

Design driven schemes with **cost effective fixed unit price fully installed** above and below ground multi cultural burial chamber solutions, including memorialisation, for any location. Facilitating pre selling with **zero environmental impact** and no additional drainage requirements giving clean, dry, safe enhanced service provision options in any location without disturbing existing remains and **no, or low ongoing maintenance cost burden to the tax payer.**



Burial Chamber Installation in saturated land



Multiple Interment Chambers -  
from £500 per interment fully installed



Support and Inscription Services



Decorative structural retaining  
walling system - multiple applications



From £1,500 per double chamber  
fully installed including memorial



Cremated Remains Features -  
from £80 per interment fully installed



6 Interment Tiber Mausoleum -  
from £40k fully installed



Maxi Mausolea -  
from £18k fully installed



Amphibian Fountain - attractive  
water feature for indoor and outdoor use



Tranquil Cemetery Village<sup>©</sup> Island  
of Peace and Reflection



Interment Support Services

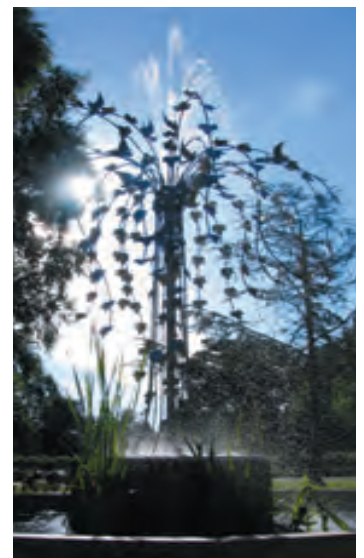

Solar Powered Tree of Life Fountain

Call now for a free survey before you waste any more money on expensive non specialist architects, high maintenance non revenue generating infrastructure and ineffective alternatives. Please ask for details of our comprehensive 'conception to completion' service including full marketing maintenance and express inscription support services.

All prices shown are excluding VAT

# welters organisation worldwide

are pleased to offer to the trade reinforced pre-cast concrete...

## FRAME LANDINGS

£54.95 each  
or £49.95 each for 10 or more

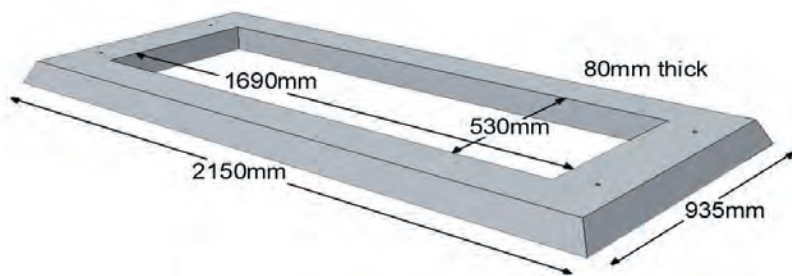

## MEMORIAL FOUNDATION PLATES

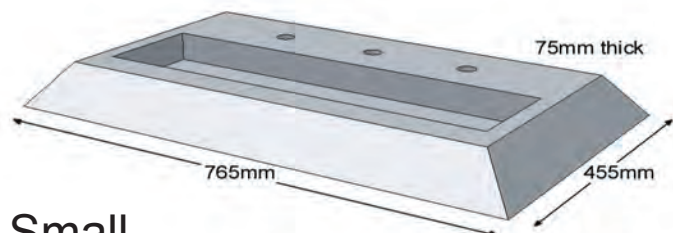

Small  
£24.95 each  
or £19.95 each for 10 or more

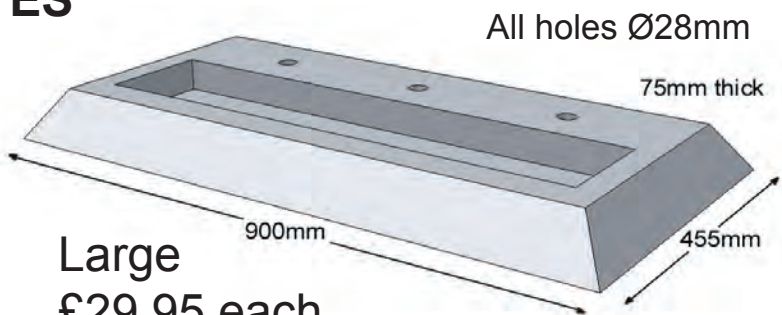

Large  
£29.95 each  
or £24.95 each for 10 or more

## GRAVE EXTENSION RINGS

Can be lifted manually into place and is a Local Authority Cemetery Order compliant solution for any shallow grave or as an alternative to a brick or block vault. Simply build up with enough sections to give the required depth, seal together and seal a set of lids on after interment which will then form the foundation for a memorial.

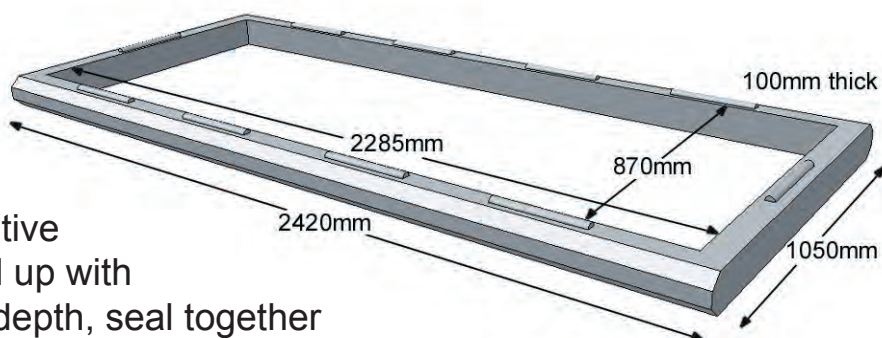

£84.95 each or £79.95 each for 10 or more

## LID SETS

Eight part interlocking 3" thick reinforced hand applied lid set to cover extension rings.

£94.95 per set  
or £89.95 per set for 10 sets or more

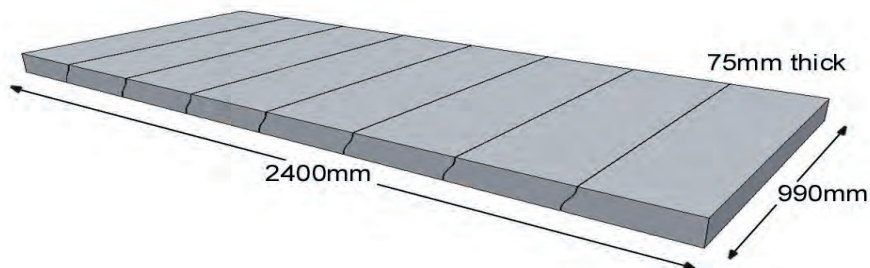

INDIVIDUAL MULTI DEPTH BURIAL CHAMBER INSTALLATION WORK NATIONALLY IN ANY LOCATION AT UNBEATABLE PRICES (INDIVIDUAL INSTALLATIONS - POA). FULL DESIGN, BUILD AND ARCHITECTURAL SERVICES AVAILABLE FOR LARGE SCHEMES WITH A FULL UNDERSTANDING OF ALL CULTURAL, PRACTICAL AND LEGAL REQUIREMENTS.

All prices plus VAT and delivery at cost. More information available on request. Please call to order on 08702 416 422.

**welters**  
ORGANISATION  
WORLDWIDE



# welters

## ORGANISATION WORLDWIDE

DESIGN AND MANAGEMENT CONSULTANTS  
RESEARCH, DEVELOPMENT AND  
MANUFACTURING

P.O. Box 159 Carlisle, Great Britain CA2 5BG  
Sales: +44(0)8702 418240 (national rate)  
Admin: +44(0)8702 416422 (national rate)  
Fax: +44(0)1228 674959  
E-mail: sales@welters-worldwide.com  
Web: www.welters-worldwide.com

## welters Cemetery Village<sup>©</sup>

### The Ultimate Funeral Experience

### Inspired Products and Services

**Have you had problems with water or a lack of space in your cemetery?** Or do you simply require a full design and build service for a beautiful and functional burial and cremation facility?

Design driven schemes with **cost effective fixed unit price fully installed** above and below ground multi cultural burial chamber solutions, including memorialisation, for any location. Facilitating pre selling with **zero environmental impact** and no additional drainage requirements giving clean, dry, safe enhanced service provision options in any location without disturbing existing remains and **no, or low ongoing maintenance cost burden to the tax payer.**



Burial Chamber Installation in saturated land



Multiple Interment Chambers -  
from £500 per interment fully installed



Full Cemetery Design and Build  
small scale/starter scheme packages



Support and Inscription Services



Architectural Services



Cremated Remains Features -  
from £80 per interment fully installed



6 Interment Tiber Mausoleum -  
from £40k fully installed



Maxi Mausolea -  
from £18k fully installed



Solar Powered Tree of Life Fountain



Amphibian Fountain - attractive  
water feature for indoor and outdoor use



Tranquil Cemetery Village<sup>©</sup> Island  
of Peace and Reflection



Interment Support Services

Call now for a free survey before you waste any more money on expensive non specialist architects, high maintenance non revenue generating infrastructure and ineffective alternatives. Please ask for details of our comprehensive 'conception to completion' service including full marketing maintenance and express inscription support services.

All prices shown are excluding VAT



Full Cemetery Design and Build

# welters

## ORGANISATION WORLDWIDE

DESIGN AND MANAGEMENT CONSULTANTS  
RESEARCH, DEVELOPMENT AND  
MANUFACTURING

P.O. Box 159 Carlisle, Great Britain CA2 5BG  
Sales: +44(0)8702 418240 (national rate)  
Admin: +44(0)8702 416422 (national rate)  
Fax: +44(0)1228 674959  
E-mail: [sales@welters-worldwide.com](mailto:sales@welters-worldwide.com)  
Web: [www.welters-worldwide.com](http://www.welters-worldwide.com)  
Please visit our website for more information.

## Can you Dig it?

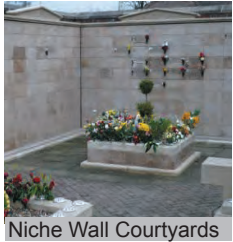

Niche Wall Courtyards



Increasingly Extreme Weather Conditions

Waterlogged Cemeteries



Decorative Stone and Granite Products



Solar Powered Tree of Life® Fountain

Have you been able to provide a seamless service throughout the winter months without cancelling any burials? Are your sites dangerous to dig or to access with funeral parties? Do you have a problem with graves full of water or unsafe memorials?

## Yes we can!

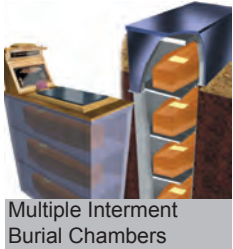

Multiple Interment Burial Chambers



Successfully opened and interred welters chamber in any conditions



Triple Interment Chamber opened for burial

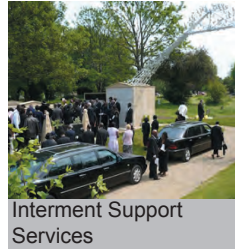

Interment Support Services



Amphibian Fountain for indoor and outdoor use



Example Cemetery Village® starter schemes



Architectural Services

### We have the solution for you.

You can invest in a beautiful architecturally designed functional revenue generating welters scheme that facilitates pre-selling, saves you space and extends the life of your cemeteries as well. We can re-train your existing staff and surplus manpower can be re-deployed elsewhere within the service.

**The ultimate in cemetery management solutions for above and below ground service provision options.**

**Transparent best value pricing policies under our single supplier status.**



Mausolea Design and Build

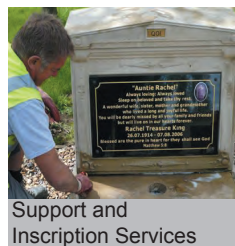

Support and Inscription Services



## Partnership Programme

## Memorial and Interment Specialists

- specialist design •manufacture •install
- full architectural services •consultation
- support services



Multi Material Design and Manufacture

# welters family mausolea range

**welters**  
ORGANISATION  
WORLDWIDE



6 interment Stone Tiber mausolea

for the lives that remain



4 interment Midi mausolea



6 interment solar Futura mausolea



6 interment Tiber mausolea



12 interment Stone mausolea



6 interment Chapel Tiber mausoleum



Burial chamber - above and below ground interment. The above chamber is clad in granite.



**welters architectural and planning services**  
Specialist bespoke mausoleum, burial chambers and private memorial design, manufacture and installation for cemetery or private estate locations.

Visit our website [www.welters-worldwide.com](http://www.welters-worldwide.com) or call or e-mail today to arrange a confidential and caring consultation.  
Tel: 08702 418 240 email [sales@welters-worldwide.com](mailto:sales@welters-worldwide.com)



Interior architectural features



Cross - granite, cast stone or bronze



Solar powered 'Tree of Life' fountain

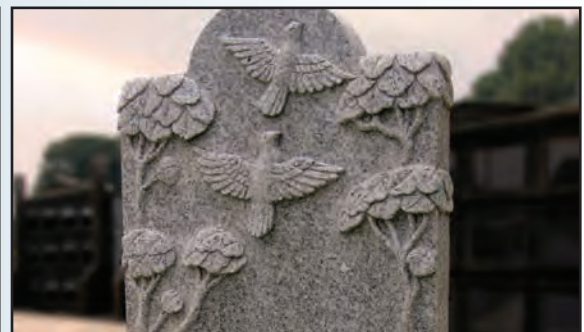

Winged Eclipse - granite, cast stone or bronze



# welters

## ORGANISATION WORLDWIDE

DESIGN AND MANAGEMENT CONSULTANTS  
RESEARCH, DEVELOPMENT AND  
MANUFACTURING

P.O. Box 159 Carlisle, Great Britain CA2 5BG  
Sales: +44(0)8702 418240 (national rate)  
Admin: +44(0)8702 416422 (national rate)  
Fax: +44(0)1228 674959  
E-mail: sales@welters-worldwide.com  
Web: www.welters-worldwide.com

## welters Cemetery Village<sup>©</sup>

### The Ultimate Funeral Experience

### Inspired Products and Services

**Have you had problems with water or a lack of space in your cemetery?** Or do you simply require a full design and build service for a beautiful and functional burial and cremation facility?

Design driven schemes with **cost effective fixed unit price fully installed** above and below ground multi cultural burial chamber solutions, including memorialisation, for any location. Facilitating pre selling with **zero environmental impact** and no additional drainage requirements giving clean, dry, safe enhanced service provision options in any location without disturbing existing remains and **no, or low ongoing maintenance cost burden to the tax payer.**



Common Grave Section Re-use - Cemetery Extension Schemes



Cremated Remains Features



Child and Baby Memorial Interment Garden



Full Cemetery Design and Build small scale/starter scheme packages

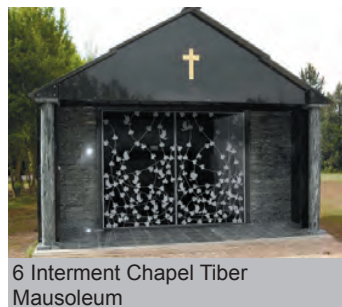

6 Interment Chapel Tiber Mausoleum



Front and Side Charging Community Mausoleum Building



Pandemic System Design, Operation and Management



Support and Inscription Services



UK specification in stock multi modular and specification burial chamber solutions fully installed



Interment Support Services

All in house manufacturing and full installation by our own specialist experts, giving the client the ultimate in 'design brief' control and cost savings of using a company that does not engage with second, third or any other sub contracted elements, with the peace of mind of our 'no questions' full on site back up support services. Projects on any scale to suit any budget. Call now for a free survey so that we may assist you with providing low maintenance, high revenue generating infrastructure and effective alternatives. Please ask for details of our comprehensive 'conception to completion' service including full marketing maintenance and express inscription support services. Prices on application.



# welters™

## ORGANISATION WORLDWIDE

DESIGN AND MANAGEMENT CONSULTANTS  
RESEARCH, DEVELOPMENT AND  
MANUFACTURING

P.O. Box 159 Carlisle, Great Britain CA2 5BG  
Sales: +44(0)8702 418240 (national rate)  
Admin: +44(0)8702 416422 (national rate)  
Fax: +44(0)1228 674959  
E-mail: sales@welters-worldwide.com  
Web: www.welters-worldwide.com

## welters™ Cemetery Village™

### The Ultimate Funeral Experience

### Inspired Products and Services

**Have you had problems with water or a lack of space in your cemetery?** Or do you simply require a full design and build service for a beautiful and functional burial and cremation facility?

Design driven schemes with **cost effective fixed unit price fully installed** above and below ground multi cultural burial chamber solutions, including memorialisation, for any location. Facilitating pre selling with **zero environmental impact** and no additional drainage requirements giving clean, dry, safe enhanced service provision options in any location without disturbing existing remains and **no, or low ongoing maintenance cost burden to the tax payer.**



Common Grave Section Re-use - Cemetery Extension Schemes



Cremated Remains Features



Child and Baby Memorial Interment Garden



Burial Chamber and Mausolea Section



6 Interment Chapel Tiber Mausoleum



A work in progress

Front and Side Charging Community Mausoleum Building



Pandemic System Design, Operation and Management



Support and Inscription Services



Private Family Vaults



Lake of Remembrance



Interment Support Services

All in house manufacturing and full installation by our own specialist experts, giving the client the ultimate in 'design brief' control and cost savings of using a company that does not engage with second, third or any other sub contracted elements, with the peace of mind of our 'no questions' full on site back up support services. Projects on any scale to suit any budget.

Call now for a free survey so that we may assist you with providing low maintenance, high revenue generating infrastructure and effective alternatives. Please ask for details of our comprehensive 'conception to completion' service including full marketing maintenance and express inscription support services. Prices on application.

# The Ultimate Funeral Experience

Inspired Products and Services

Interment and Memorial Specialists



welters™ Cemetery Village™ Schemes

# welters™

ORGANISATION  
WORLDWIDE

DESIGN AND MANAGEMENT CONSULTANTS  
RESEARCH, DEVELOPMENT AND  
MANUFACTURING

P.O. Box 159 Carlisle, Great Britain CA2 5BG

Sales: +44(0)8702 418240 (national rate)

Admin: +44(0)8702 416422 (national rate)

Fax: +44(0)1228 674959

E-mail: [sales@welters-worldwide.com](mailto:sales@welters-worldwide.com)

Web: [www.welters-worldwide.com](http://www.welters-worldwide.com)



Cemetery Village™ Scheme with Below Ground Double Burial Chambers, Side Charging Mausolea and Portico of Peace™ Entrance Feature



Existing Cemetery Space Re-use and Extension - Double Burial Chambers Over Common Graves Area with Classic 900 Stone and Granite Memorials



Classic Grande Memorial Housings over Double Chambers and Mausolea Systems



Cemetery Village™ with Mausolea, Double Burial Chambers and Centre Features



Triple Depth Burial Chamber with Top Interment Above Ground and Clad in Granite



Glades of Remembrance Lake Project



Child/Baby Memorial Garden with Neptune Centre Feature, Cremation Niche Systems, Keepsake Building and Child, Baby & Communal Burial Chambers



Cemetery Village™ with Magnificent Entrance Feature



Bespoke Mausolea Design and Installation



Double Burial Chamber with Classic Stone Housing System



Environment Policy - one tree planted for every interment



Community Mausolea Design and Build Projects

- Marketing and promotional services
- Maintenance support services
- Training services
- Conception to completion turnkey projects
- Design, Manufacture, Install
- High water tablet installations
- Fully networked 'back up' support 'around the clock'
- Emergency express burial chamber installation service

- New cemetery, cemetery extension and common section re-use design and build
- Shallow grave solution design, manufacture, install
- Installation, construction and drainage
- Landscape design and finishing
- Inscription and support services
- Interment and sealing up procedure services
- Cemetery and facilities management



# welters™ organisation worldwide

– the Pioneer Cemetery Design and Build Company with over 20 years market service and expertise celebrates yet another year of leadership in concept manufacture, installation and management. welters™ experience and success combines as a result of ongoing commitment to invest in research and development.



Cemetery Village™ - Project Open Day

welters™ provide comprehensive 'in house' architectural services specialising in cemetery architecture with complete specialist design and planning, manufacturing, installation and construction services.

Local Authority Cemetery Services, following the Second World War and the growth of cremation numbers, became

dissipated and the will, knowledge and dedication to conceive, create and implement effective, desirable and financially viable Cemetery Services faded into insignificance in the face of the sanitised 'conveyor' solution that for the time being became, and to some extent still is, popular.

There is a lot of talk about change. The government wants change, ever increasing variety and partnerships. We talk about forward planning and innovation, but generally, there is still not a lot happening. We believe that change needs a kick start, and that great vision is required in this modern day of computers and disposable culture to improve the quality, the variety and artistic inspiration of our products and services as future generations will very soon have nothing to be inspired by from this period.



Chapel Restoration and Interior Niche Installation - Project Open Day

welters™ organisation, with the thorough awareness and understanding of the emotional and cultural requirements of the bereaved and the legal, management and technical ability to provide excellent solutions and at all times have continually expanded their full range of in house services.

welters™ have carefully moulded the development of the business to apply to the specific

and broad ranging issues affecting the client base. We have learned that because we have worked hard to manufacture all of our products and develop all of the skills required 'in house', we find more and more customers benefiting from our 'complete package service ability'. From architectural and planning through to bespoke scheme design, product manufacture/supply and complete installation, with PR and marketing support services also being very popular.

Our customers are experiencing direct benefits where it counts, like having ultimate control over project brief, specification and aesthetics based on our detailed proposals. They are utilising the benefits of dealing with one company who has specialist experience and ability in all of these areas which also gives them economies of scale and the ability to instruct us on single supplier



Cremated Remains Niche Interment Installation - Project Open Day

basis where necessary.

welters™ systems and ability to specify multi modular and varying finish solutions facilitate pre-selling with zero environmental impact and no additional drainage requirements giving clean, safe, space saving, UK specification LACO compliant enhanced service provision options in any location without disturbing existing remains and no, or low ongoing maintenance cost burden making it a viable priced solution for the bereaved.

All ideas, solutions, manufacturing and 24/7 back up support essentially must be generated from within the company and cannot, be structured from a 'mis-mash' of sub-contracted 'bit parts' with no dedication, inadequate knowledge or control.

The development of an environment to embrace culture, emotion and spirituality through excellent design and technical performance is an art form in its own right. welters™ have perfected these skills, linked with performance design which over many years has resolved and overcome almost every conceivable land use issue from sub water tablet construction to re-use and contaminated status.

Good environmental solution is inextricably linked with economic viability and the true and fundamental requirement and responsibility of mankind to respect and remember its dead.

welters™ mission continues to be to research and develop inspirational and classic designs, higher quality products, space saving and safe solutions for cost effective supply and installation.



Child/Baby Memorial Garden - Project Open Day

# welters™

ORGANISATION  
WORLDWIDE  
DESIGN AND MANAGEMENT CONSULTANTS

## NEWS RELEASE



Glades of Remembrance - Project Open Day



Niche Garden Complex for Cremated Remains Interment - Project Open Day



Interior Chapel Niche System - Open Day

# The Ultimate Funeral Experience

Inspired Products and Services

Interment and Memorial Specialists



welters™ Cemetery Village™ Schemes

# welters™

ORGANISATION  
WORLDWIDE

DESIGN AND MANAGEMENT CONSULTANTS  
RESEARCH, DEVELOPMENT AND  
MANUFACTURING

P.O. Box 159 Carlisle, Great Britain CA2 5BG

Sales: +44(0)8702 418240 (national rate)

Admin: +44(0)8702 416422 (national rate)

Fax: +44(0)1228 674959

E-mail: [sales@welters-worldwide.com](mailto:sales@welters-worldwide.com)

Web: [www.welters-worldwide.com](http://www.welters-worldwide.com)



Cemetery Village™ Scheme with Below Ground Double Burial Chambers, Side Charging Mausolea and Portico of Peace™ Entrance Feature



Existing Cemetery Space Re-use and Extension - Double Burial Chambers Over Common Graves Area with Classic 900 Stone and Granite Memorials



New Classic Embankment Community Mausolea Schemes



Cemetery Village™ with Mausolea, Double Burial Chambers and Centre Features



Triple Depth Burial Chamber with Top Interment Above Ground and Clad in Granite



Glades of Remembrance Lake Project



Child/Baby Memorial Garden with Neptune Centre Feature, Cremation Niche Systems, Keepsake Building and Child, Baby & Communal Burial Chambers



Cemetery Village™ with Magnificent Entrance Feature



Bespoke Mausolea Design and Installation



Double Burial Chamber with Classic Stone Housing System



Environment Policy - one tree planted for every interment



Community Mausolea Design and Build Projects

- Marketing and promotional services
- Maintenance support services
- Training services
- Conception to completion turnkey projects
- Design, Manufacture, Install
- High water tablet installations
- Fully networked 'back up' support 'around the clock'
- Emergency express burial chamber installation service

- New cemetery, cemetery extension and common section re-use design and build
- Shallow grave solution design, manufacture, install
- Installation, construction and drainage
- Landscape design and finishing
- Inscription and support services
- Interment and sealing up procedure services
- Cemetery and facilities management

# The Ultimate Funeral Experience

Inspired Products and Services

Interment and Memorial Specialists



## Partnership Programme

### welters® Cemetery Village® Schemes

# welters®

## ORGANISATION WORLDWIDE

DESIGN AND MANAGEMENT CONSULTANTS  
RESEARCH, DEVELOPMENT AND  
MANUFACTURING

P.O. Box 159 Carlisle, Great Britain CA2 5BG

Sales: +44(0)8702 418240 (national rate)

Admin: +44(0)8702 416422 (national rate)

Fax: +44(0)1228 674959

E-mail: [sales@welters-worldwide.com](mailto:sales@welters-worldwide.com)

Web: [www.welters-worldwide.com](http://www.welters-worldwide.com)



Cemetery Village® Scheme with Below Ground Double Burial Chambers, Side Charging Mausolea and Portico of Peace™ Entrance Feature



Existing Cemetery Space Re-use and Extension - Double Burial Chambers Over Common Graves Area with Classic 900 Stone and Granite Memorials



New Classic Embankment Community Mausolea Schemes



Cemetery Village® with Mausolea, Double Burial Chambers and Centre Features



Triple Depth Burial Chamber with Top Interment Above Ground and Clad in Granite



Glades of Remembrance Lake Project



Child/Baby Memorial Garden with Neptune Centre Feature, Cremation Niche Systems, Keepsake Building and Child, Baby & Communal Burial Chambers



Cemetery Village® with Magnificent Entrance Feature



Bespoke Mausolea Design and Installation



Double Burial Chamber with Classic Stone Housing System



Environment Policy - one tree planted for every interment



Community Mausolea Design and Build Projects

- Marketing and promotional services
- Maintenance support services
- Training services
- Conception to completion turnkey projects
- Design, Manufacture, Install
- High water tablet installations
- Fully networked 'back up' support 'around the clock'
- Emergency express burial chamber installation service

- New cemetery, cemetery extension and common section re-use design and build
- Shallow grave solution design, manufacture, install
- Installation, construction and drainage
- Landscape design and finishing
- Inscription and support services
- Interment and sealing up procedure services
- Cemetery and facilities management

# welters® organisation worldwide

– the Pioneer Cemetery Design and Build Company with over 20 years market service and expertise celebrates yet another year of leadership in concept manufacture, installation and management. **welters®** experience and success combines as a result of ongoing commitment to invest in research and development.



welters® River Garden - for cremated remains memorialisation and interment

**welters®** provide comprehensive 'in house' architectural services specialising in cemetery architecture with complete specialist services.

Local Authority Cemetery Services, following the Second World War and the growth of cremation numbers, became dissipated and the will, knowledge and dedication to conceive, create and implement effective, desirable and financially viable Cemetery Services faded into insignificance in the face of the sanitised 'conveyor' solution that for the time being became, and to some extent is still, popular.

There is a lot of talk about change. The government wants change, ever increasing variety and partnerships. We talk about forward planning and innovation, but generally, there is still not a lot happening. We believe that change needs a kick start, and that great vision is required in this modern day of computers and disposable culture to improve the quality, the variety and artistic inspiration of our products and services as alternatively, future generations will very soon have nothing to be inspired by from this period.

**welters® organisation**, with the thorough awareness and understanding of the emotional and cultural requirements of the bereaved and the legal, management and technical ability to provide excellent solutions



welters® River Garden - an underwater wonderworld of peace and reflection

and at all times have continually expanded their full range of in house services.

**welters®** have carefully moulded the development of the business to apply to the specific and broad ranging issues affecting the client base. We have learned that because we have worked hard to manufacture all of our products and develop all of the skills required 'in house', we find more and more customers benefiting from our 'complete package service ability'. **welters®** provide architectural design and planning through to bespoke scheme

design, product manufacture/supply and complete installation, with PR and marketing support services also being very popular.

Our customers are experiencing direct benefits where it counts, like having ultimate control over project brief, specification and aesthetics based on our detailed proposals. They are utilising the benefits of dealing with one company who has specialist experience and ability in all of these areas which also gives them economies of scale and the ability to instruct us on a single supplier basis where necessary.

**welters®** systems and ability to specify multi modular and varying finish solutions facilitate pre-selling with zero environmental impact and no additional drainage requirements. This creates

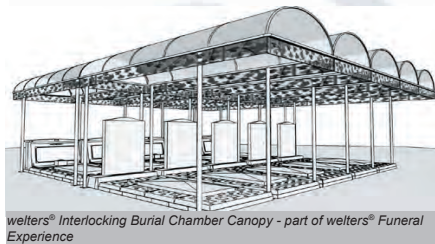

welters® Interlocking Burial Chamber Canopy - part of welters® Funeral Experience

clean, safe, space saving, UK specification LACO compliant enhanced service provision options. **welters®** systems can be utilised in any location without disturbing existing remains and no, or low ongoing maintenance cost burden making it a viable priced solution for the bereaved.

All ideas, solutions, manufacturing and 24/7 back up support essentially must be generated from within the company and cannot, be structured from a 'mis-mash' of sub-contracted 'bit parts' with an absence of dedication, inadequate knowledge or control.

The development of an environment to embrace culture, emotion and spirituality through excellent design and technical performance is an art form in its own right. **welters®** have perfected these skills, linked with performance design which over many years has resolved and overcome almost every conceivable land use issue from sub water table construction to re-use and contaminated status.

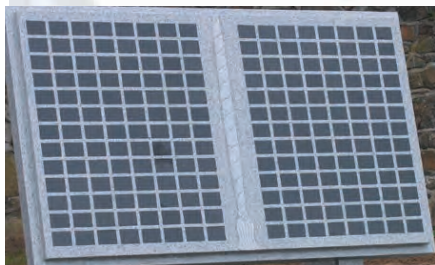

welters® Large Memorial Inscription Book - light grey polished granite with black granite inscription tablets and tassle detail

Good environmental solution is inextricably linked with economic viability and the true and fundamental requirement and responsibility of mankind to respect and remember its dead.

**welters®** mission continues to be to research and develop inspirational and classic designs, higher quality products, space saving and safe solutions for cost effective supply and installation.

# welters® ORGANISATION WORLDWIDE

DESIGN AND MANAGEMENT CONSULTANTS  
RESEARCH, DEVELOPMENT AND  
MANUFACTURING

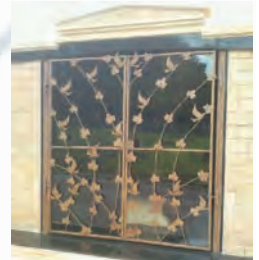

welters® Decorative Stone 9 Interment Family Chapel Mausoleum



welters® 6 Interment Front Chargin Glass Tiber with integrated seating and planters



welters® Grand Customised Burial Crypts

# The Ultimate Funeral Experience

Inspired Products and Services

Interment and Memorial Specialists



welters® Cemetery Village® Schemes

# welters®

ORGANISATION  
WORLDWIDE

DESIGN AND MANAGEMENT CONSULTANTS  
RESEARCH, DEVELOPMENT AND  
MANUFACTURING

P.O. Box 159 Carlisle, Great Britain CA2 5BG

Sales: +44(0)8702 418240 (national rate)

Admin: +44(0)8702 416422 (national rate)

Fax: +44(0)1228 674959

E-mail: [sales@welters-worldwide.com](mailto:sales@welters-worldwide.com)

Web: [www.welters-worldwide.com](http://www.welters-worldwide.com)



Classic Premier Polished Granite Memorial Systems



Classic Embankment Community and Private Mausolea Schemes



Niche Interment Systems with Decorative Planters and Seating



Decorative Stone Community Mausolea with Planters and Seating



High Specification Memorialisation above Multiple Depth Burial Chambers



Classic Grande Memorial Systems on long established site



Muslim Burial Chamber and Interment Ring Installations



Child/Baby Memorial Garden with Neptune Centre Feature, Cremation Niche Systems, Keepsake Building and Child, Baby & Communal Burial Chambers



Cemetery Village™ with Magnificent Entrance Feature



Bespoke Mausolea Design and Installation



Double Burial Chamber with Classic Stone Housing System



Environment Policy - one tree planted for every interment



Community Mausolea Design and Build Projects

Email a request for specialist information concerning the welters Grand Customised Burial Crypts - [burialcrypts@welters-worldwide.com](mailto:burialcrypts@welters-worldwide.com)

- Marketing and promotional services
- Maintenance support services
- Training services
- Conception to completion turnkey projects
- Design, Manufacture, Install
- High water tablet installations
- Fully networked 'back up' support 'around the clock'
- Emergency express burial chamber installation service
- New cemetery, cemetery extension and common section re-use design and build
- Shallow grave solution design, manufacture, install
- Installation, construction and drainage
- Landscape design and finishing
- Inscription and support services
- Interment and sealing up procedure services
- Cemetery and facilities management

# The Ultimate Funeral Experience

Inspired Products and Services

Interment and Memorial Specialists



welters® Cemetery Village® Schemes

# welters®

## ORGANISATION WORLDWIDE

DESIGN AND MANAGEMENT CONSULTANTS  
RESEARCH, DEVELOPMENT AND  
MANUFACTURING

P.O. Box 159 Carlisle, Great Britain CA2 5BG

Sales: +44(0)8702 418240 (national rate)

Admin: +44(0)8702 416422 (national rate)

Fax: +44(0)1228 674959

E-mail: [sales@welters-worldwide.com](mailto:sales@welters-worldwide.com)

Web: [www.welters-worldwide.com](http://www.welters-worldwide.com)



Circular column installation



welters® Majestic Community Mausolea with side charging, front charging and cremated remains interments - virtual representation



welters® Majestic Community Mausolea - work in progress



Circular column with decorative leaves and butterfly ferro work



welters® Burial Village® Cemetery Art - Cremated Remains Interment



welters® Majestic Community Mausolea - work in progress



Specially design roof panel section installation



welters® Burial Village® Cemetery Art - Full Body Interment



welters® Cremated Remains Orb Memorial Garden Feature



welters® Cremated Remains Orb - available in 3 sizes

Email a request for specialist information concerning the welters Grand Customised Burial Crypts - [burialcrypts@welters-worldwide.com](mailto:burialcrypts@welters-worldwide.com)

- Marketing and promotional services
- Maintenance support services
- Training services
- Conception to completion turnkey projects
- Design, Manufacture, Install
- High water tablet installations
- Fully networked 'back up' support 'around the clock'
- Emergency express burial chamber installation service
- New cemetery, cemetery extension and common section re-use design and build
- Shallow grave solution design, manufacture, install
- Installation, construction and drainage
- Landscape design and finishing
- Inscription and support services
- Interment and sealing up procedure services
- Cemetery and facilities management

# The Ultimate Funeral Experience

Inspired Products and Services

Interment and Memorial Specialists



welters® Cemetery Village® Schemes

# welters®

ORGANISATION  
WORLDWIDE

DESIGN AND MANAGEMENT CONSULTANTS  
RESEARCH, DEVELOPMENT AND  
MANUFACTURING

P.O. Box 159 Carlisle, Great Britain CA2 5BG

Sales: +44(0)8702 418240 (national rate)

Admin: +44(0)8702 416422 (national rate)

Fax: +44(0)1228 674959

E-mail: [sales@welters-worldwide.com](mailto:sales@welters-worldwide.com)

Web: [www.welters-worldwide.com](http://www.welters-worldwide.com)



welters® Cremated Remains Orb  
- available in 3 sizes



welters® Majestic Community Mausolea with side charging, front charging and cremated remains interments

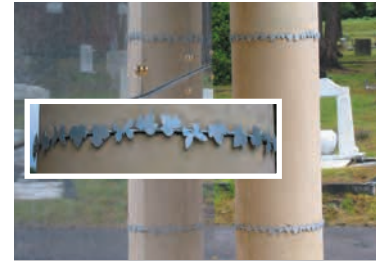

Delicated decorative ferro work around stone columns



Yet another example of a successful re-opening of a formally terminated London burial space



Two interments below ground

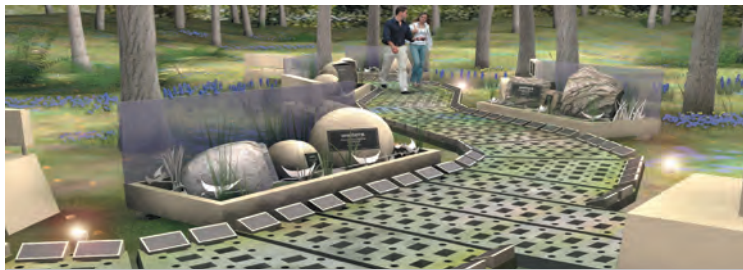

welters® Forest Walkway incorporating memorial orbs in granite, stone and timber with seating and inscription opportunities

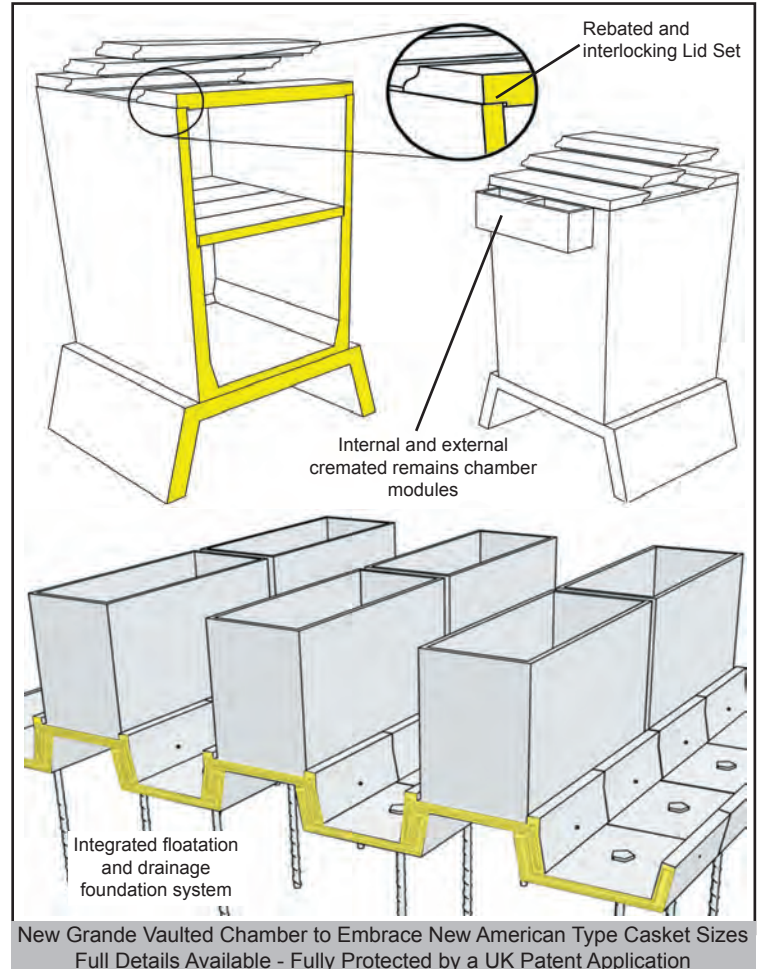

Email a request for specialist information concerning the welters® Grand Customised Burial Crypts - [burialcrypts@welters-worldwide.com](mailto:burialcrypts@welters-worldwide.com)

- Marketing and promotional services
- Maintenance support services
- Training services
- Conception to completion turnkey projects
- Design, Manufacture, Install
- High water tablet installations
- Fully networked 'back up' support 'around the clock'
- Emergency express burial chamber installation service

- New cemetery, cemetery extension and common section re-use design and build
- Shallow grave solution design, manufacture, install
- Installation, construction and drainage
- Landscape design and finishing
- Inscription and support services
- Interment and sealing up procedure services
- Cemetery and facilities management

# welters™

ORGANISATION  
WORLDWIDE

DESIGN AND MANAGEMENT CONSULTANTS  
RESEARCH, DEVELOPMENT AND  
MANUFACTURING

PO Box 159, Carlisle, Great Britain, CA2 5BG  
Admin Tel: 08702 416422 (standard national rate)  
Fax: 01228 674 959

Website: [www.welters-worldwide.com](http://www.welters-worldwide.com)  
Email: [sales@welters-worldwide.com](mailto:sales@welters-worldwide.com)

## welters family mausolea™ range

- Bespoke design, manufacture & install service
- Existing chapel/building conversion/restoration service
- Standard, Classic & Premier options
- Cemeteries, garden or private estate
- Memorial & Interment Specialists

...for the lives that remain

6 interment Stone Tiber mausolea



4 interment Midi mausolea



6 interment Chapel Tiber mausoleum



6 interment Tiber mausolea



12 interment Stone mausolea



Winged Eclipse - granite, cast stone or bronze

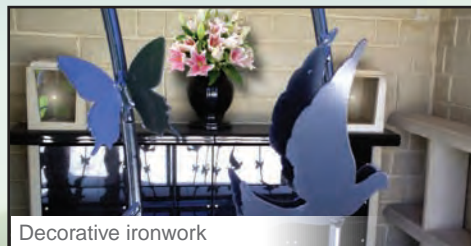

Decorative ironwork



Interior architectural features



Burial chamber - above and below ground interment. The above chamber is clad in granite.



Solar powered 'Tree of Life' fountain



Solar powered 'Tree of Life' fountain

### welters™ architectural and planning services

Specialist bespoke mausoleum, burial chambers and private memorial design, manufacture and installation for cemeteries, garden or private estate locations.

Visit our website [www.welters-worldwide.com](http://www.welters-worldwide.com)  
or call or e-mail today to enquire about our confidential and free consultation and site survey

Tel: 08702 418 240 email [sales@welters-worldwide.com](mailto:sales@welters-worldwide.com)



Cross - granite, cast stone or bronze

A British design driven manufacturing company with four generations of expertise, using a combination of modern manufacturing technology and traditional in-house skills from our UK base



# The Ultimate Funeral Experience

Inspired Products and Services

Interment and Memorial Specialists



Partnership  
Programme

welters® Cemetery Village® Schemes

# welters®

ORGANISATION  
WORLDWIDE

DESIGN AND MANAGEMENT CONSULTANTS  
RESEARCH, DEVELOPMENT AND  
MANUFACTURING

P.O. Box 159 Carlisle, Great Britain CA2 5BG

Sales: +44(0)8702 418240 (national rate)

Admin: +44(0)8702 416422 (national rate)

Fax: +44(0)1228 674959

E-mail: [sales@welters-worldwide.com](mailto:sales@welters-worldwide.com)

Web: [www.welters-worldwide.com](http://www.welters-worldwide.com)



Decorative stone embankment community mausolea



welters® Majestic Community Mausolea with side charging, front charging and cremated remains interments

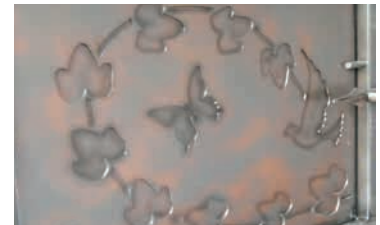
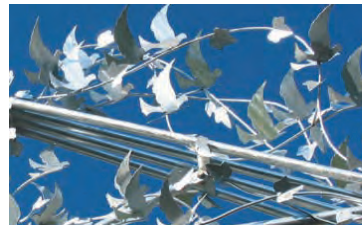

Decorative stone, steel, glass, granite, bronze and ferro work



Work in progress



Decorative stone 9 interment family chapel mausoleum



welters® Cremated Remains Memorial Systems

**We can use land that no one else can. Think you have run out of space? Think again. Call welters® for cost effective and viable solutions.**

- Marketing and promotional services
- Maintenance support services
- Training services
- Conception to completion turnkey projects
- Design, Manufacture, Install
- High water tablet installations
- Fully networked 'back up' support 'around the clock'
- Emergency express burial chamber installation service

- New cemetery, cemetery extension and common section re-use design and build
- Shallow grave solution design, manufacture, install
- Installation, construction and drainage
- Landscape design and finishing
- Inscription and support services
- Interment and sealing up procedure services
- Cemetery and facilities management

# The Ultimate Funeral Experience

Inspired Products and Services

Interment and Memorial Specialists



welters® Cemetery Village® Schemes

# welters®

## ORGANISATION WORLDWIDE

DESIGN AND MANAGEMENT CONSULTANTS  
RESEARCH, DEVELOPMENT AND  
MANUFACTURING

P.O. Box 159 Carlisle, Great Britain CA2 5BG

Sales: +44(0)8702 418240 (national rate)

Admin: +44(0)8702 416422 (national rate)

Fax: +44(0)1228 674959

E-mail: [sales@welters-worldwide.com](mailto:sales@welters-worldwide.com)

Web: [www.welters-worldwide.com](http://www.welters-worldwide.com)



Decorative Stone Embankment Community Mausolea

These examples of granite memorials are only a small part of an extensive range - please request further details from [sales@welters-worldwide.com](mailto:sales@welters-worldwide.com)



Granite Burial and Cremation Safe Memorials Systems



Double Interment Curved Chamber installation above existing graves - stepping up out of the ground towards the above ground Sarcophagi



Large Granite Book Memorial



Granite Niche Memorials



Granite Heritage Full Body Burial Safe Memorials Systems



welters® Majestic Community Mausolea with side charging, front charging and cremated remains interments



Small Granite Book Memorials



Granite Cremation Orb Memorials

**Procurement officers are requested to submit all bereavement services requisition requirement to [admin@welters-worldwide.com](mailto:admin@welters-worldwide.com) for our response to tender requests.**

- Marketing and promotional services
- Maintenance support services
- Training services
- Conception to completion turnkey projects
- Design, Manufacture, Install
- High water tablet installations
- Fully networked 'back up' support 'around the clock'
- Emergency express burial chamber installation service

- New cemetery, cemetery extension and common section re-use design and build
- Shallow grave solution design, manufacture, install
- Installation, construction and drainage
- Landscape design and finishing
- Inscription and support services
- Interment and sealing up procedure services
- Cemetery and facilities management

# The Ultimate Funeral Experience

Inspired Products and Services

Interment and Memorial Specialists



welters® Cemetery Village® Schemes

# welters®

ORGANISATION  
WORLDWIDE

DESIGN AND MANAGEMENT CONSULTANTS  
RESEARCH, DEVELOPMENT AND  
MANUFACTURING

P.O. Box 159 Carlisle, Great Britain CA2 5BG

Sales: +44(0)8702 418240 (national rate)

Admin: +44(0)8702 416422 (national rate)

Fax: +44(0)1228 674959

E-mail: [sales@welters-worldwide.com](mailto:sales@welters-worldwide.com)

Web: [www.welters-worldwide.com](http://www.welters-worldwide.com)



Keepsake and cremated remains niche columns with lockable doors



welters® Convex Coliseum Mausoleum option shown takes 36 front charging interments



welters® Majestic 'Amphi' Mausolea with niche columns

**welters® - masters of design and innovation - now opening spiritual vistas through flexible shape and form**



welters® Convex Coliseum Mausoleum - curved to continue around any corner. Columns between cells for cremated remains or keepsakes



Double Interment Curved Chamber installation above existing graves - stepping up out of the ground towards the above ground Sarcophagi

**Procurement officers are requested to submit all bereavement services requisition requirement to [admin@welters-worldwide.com](mailto:admin@welters-worldwide.com) for our response to tender requests.**

- Marketing and promotional services
- Maintenance support services
- Training services
- Conception to completion turnkey projects
- Design, Manufacture, Install
- High water table installations
- Fully networked 'back up' support 'around the clock'
- Emergency express burial chamber installation service
- New cemetery, cemetery extension and common section re-use design and build
- Shallow grave solution design, manufacture, install
- Installation, construction and drainage
- Landscape design and finishing
- Inscription and support services
- Interment and sealing up procedure services
- Cemetery and facilities management

**Advertisement Order Form 2012**

<b>Company Name &amp; Address:</b>	<b>Contact Name: KEITH WELTERS</b>
<b>WELTERS ORGANISATION WORLDWIDE</b>	<b>Date of Order: 6<sup>th</sup> December 2011</b>
<b>PO BOX 159</b>	<b>Your Ref:</b>
<b>CARLISLE CA2 5BG</b>	<b>Special Instructions:</b>
<b>Telephone: 08702 416422</b>	
<b>Facsimile: 01228 674959</b>	<b>E-mail: admin@welters-worldwide.com</b>
<b>Artwork supplied: Yes/No Yes</b>	<b>Artwork chargeable: Yes/No No</b>
<b>Artwork to be created: Yes/No No</b>	<b>Comments:</b>

	<b>Spring 2012</b>	<b>Summer 2012</b>	<b>Autumn 2012</b>	<b>Winter 2012</b>
<b>Size</b>	<b>A4</b>	<b>A4</b>	<b>A4</b>	<b>A4</b>
<b>Colour</b>	<b>Yes</b>	<b>Yes</b>	<b>Yes</b>	<b>Yes</b>
<b>Position</b>				
<b>Gross (£)</b>	<b>£483.00</b>	<b>£483.00</b>	<b>£483.00</b>	<b>FREE</b>

**Artwork**

**Artwork to be supplied in QuarkXpress 7, Photoshop CS2, Illustrator CS2, or generic EPS, TIFF, JPEG or Hi Res PDF (300 dpi, CMYK, 4mm bleed with crop marks). Please remember to include all fonts and images and a colour proof. To be supplied on CD/DVD or by e-mail to ([pharos.international@cremation.org.uk](mailto:pharos.international@cremation.org.uk)). If Pharos has to create your artwork this will be charged extra.**

We hereby confirm the above order and acknowledge the terms and conditions as set out on the reverse of this document

Signed for and on behalf of **Welters Organisation Worldwide**. *Steve Wain* **Date:** 17.01.12

This acknowledgement is confirmation of your booking which constitutes a contract and is subject to our usual terms and conditions

Signed for and on behalf of **The Cremation Society of GB**.....**Date:**.....

**The Cremation Society of Great Britain**

Publications Dept  
Brecon House (1<sup>st</sup> Floor)  
16/16a Albion Place  
Maidstone, Kent, ME14 5DZ

Tel: (01622) 688292/3 Fax: (01622) 686698 E-mail: [pharos.international@cremation.org.uk](mailto:pharos.international@cremation.org.uk)  
Web: [www.cremation.org.uk](http://www.cremation.org.uk)

# The Ultimate Funeral Experience

Inspired Products and Services

Interment and Memorial Specialists



welters® Cemetery Village® Schemes

# welters®

ORGANISATION  
WORLDWIDE

DESIGN AND MANAGEMENT CONSULTANTS  
RESEARCH, DEVELOPMENT AND  
MANUFACTURING

P.O. Box 159 Carlisle, Great Britain CA2 5BG

Sales: +44(0)8702 418240 (national rate)

Admin: +44(0)8702 416422 (national rate)

Fax: +44(0)1228 674959

E-mail: [sales@welters-worldwide.com](mailto:sales@welters-worldwide.com)

Web: [www.welters-worldwide.com](http://www.welters-worldwide.com)

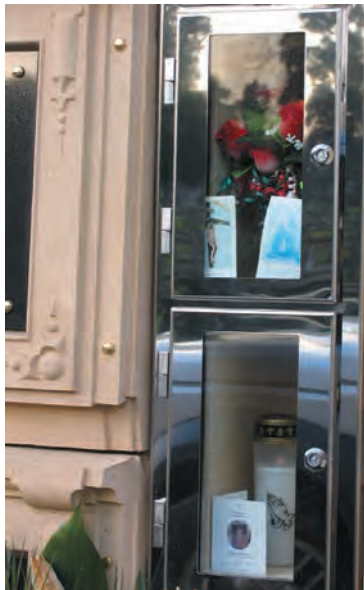

Keepsake and cremated remains niche columns with lockable doors



welters® Convex Coliseum Mausoleum option shown takes 36 front charging interments

welters® Majestic 'Amphi' Mausolea with niche columns

**welters® - masters of design and innovation - now opening spiritual vistas through flexible shape and form**



Double Interment Concentric Chamber installation above existing graves - second phase installation under construction. Virtual representation shows the finished second phase development with a decorative octagonal centre feature. The below ground interment provision can be seen from this vantage point.



**Procurement officers are requested to submit all bereavement services requisition requirement to [admin@welters-worldwide.com](mailto:admin@welters-worldwide.com) for our response to tender requests.**

- Marketing and promotional services
- Maintenance support services
- Training services
- Conception to completion turnkey projects
- Design, Manufacture, Install
- High water table installations
- Fully networked 'back up' support 'around the clock'
- Emergency express burial chamber installation service
- New cemetery, cemetery extension and common section re-use design and build
- Shallow grave solution design, manufacture, install
- Installation, construction and drainage
- Landscape design and finishing
- Inscription and support services
- Interment and sealing up procedure services
- Cemetery and facilities management

# The Ultimate Funeral Experience

Inspired Products and Services

Interment and Memorial Specialists



welters® Cemetery Village® Schemes

# welters®

ORGANISATION  
WORLDWIDE

DESIGN AND MANAGEMENT CONSULTANTS  
RESEARCH, DEVELOPMENT AND  
MANUFACTURING

P.O. Box 159 Carlisle, Great Britain CA2 5BG

Sales: +44(0)8702 418240 (national rate)

Admin: +44(0)8702 416422 (national rate)

Fax: +44(0)1228 674959

E-mail: [sales@welters-worldwide.com](mailto:sales@welters-worldwide.com)

Web: [www.welters-worldwide.com](http://www.welters-worldwide.com)



Keepsake and cremated remains niche columns with lockable doors



A second phase work in progress installation of welters® Majestic Mausoleum incorporating a mix of front and side charging interment options with granite tablets for inscriptions and an attractive communal planter arrangement.



welters® Amphi Majestic Mausolea comprising front and side charging mausolea interments as well as decorative stone columns and detailing



welters® Chiltern Memorial Bench with cremated remains or keepsake niches with either granite cover tablet or sstl door options



welters® Specialist Mausolea Charging Bier for interment services - part of welters® continuous care programme



welters® Full Body Casket - available in bronze and stainless steel options

**Procurement officers are requested to submit all bereavement services requisition requirement to [admin@welters-worldwide.com](mailto:admin@welters-worldwide.com) for our response to tender requests.**

- Marketing and promotional services
- Maintenance support services
- Training services
- Conception to completion turnkey projects
- Design, Manufacture, Install
- High water table installations
- Fully networked 'back up' support 'around the clock'
- Emergency express burial chamber installation service

- New cemetery, cemetery extension and common section re-use design and build
- Shallow grave solution design, manufacture, install
- Installation, construction and drainage
- Landscape design and finishing
- Inscription and support services
- Interment and sealing up procedure services
- Cemetery and facilities management



welters<sup>®</sup>  
ORGANISATION  
WORLDWIDE

## The Ultimate Funeral Experience

Mausolea | Burial Chambers | Niche Interment Facilities | Memorials | Ancillary products

Visit us at [www.welters-worldwide.com](http://www.welters-worldwide.com)

Training | Support | Maintenance | Continuous Care | Partnerships | Part and Fully Funded Projects

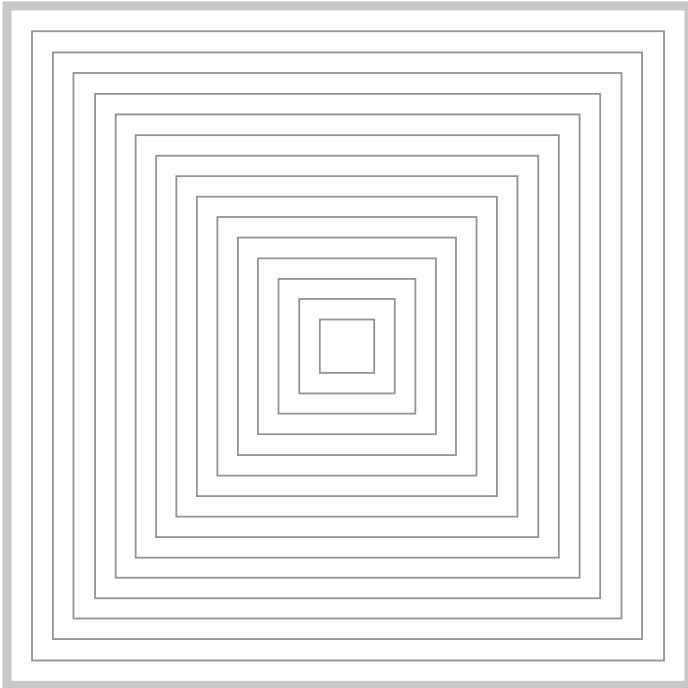

© Copyright welters 1962

Since 1997 **welters®** have advertised without interruption, products and services for the Bereavement Industry and its officers within **The Journal**.

The breadth and scope of **welters®** operations today and the launch of the **2012 Prospectus and Manifesto** are now available by visiting:

**[www.welters-worldwide.com](http://www.welters-worldwide.com)**

**welters®**  
ORGANISATION  
WORLDWIDE



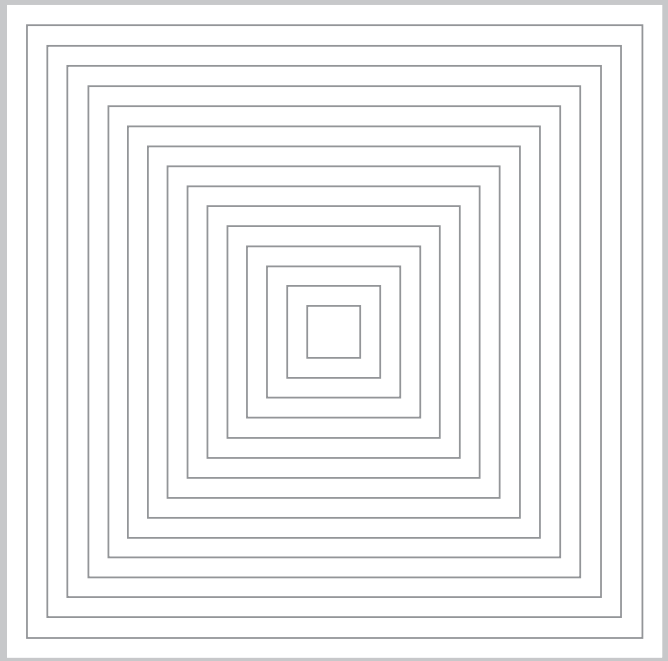

© Copyright welters 1962

Since 2001 **welters®** have advertised without interruption, products and services for the Bereavement Industry and its officers within **PHAROS INTERNATIONAL**.

The breadth and scope of **welters®** operations today and the launch of the **2012 Prospectus and Manifesto** are now available by visiting:

**[www.welters-worldwide.com](http://www.welters-worldwide.com)**

**welters®**  
ORGANISATION  
WORLDWIDE

# The Ultimate Funeral Experience

Inspired Products and Services

Interment and Memorial Specialists



welters® Cemetery Village® Schemes

# welters®

## ORGANISATION WORLDWIDE

DESIGN AND MANAGEMENT CONSULTANTS  
RESEARCH, DEVELOPMENT AND  
MANUFACTURING

P.O. Box 159 Carlisle, Great Britain CA2 5BG

Sales: +44(0)8702 418240 (national rate)

Admin: +44(0)8702 416422 (national rate)

Fax: +44(0)1228 674959

E-mail: [sales@welters-worldwide.com](mailto:sales@welters-worldwide.com)

Web: [www.welters-worldwide.com](http://www.welters-worldwide.com)



Introducing welters® Majestic Memorial Mausolea which provides space for 4 sets of cremated remains in welters® bespoke caskets. The system can be installed in a number of configurations and is available in a wide variety of materials and finishes



welters® Orbs are available in a range of sizes and materials and are designed for the interment of Cremated Remains in welters® bespoke caskets



welters® Chiltern Memorial Bench with cremated remains or keepsake niches with either granite cover tablet or stainless steel door options



Below ground burial chambers and above ground Sarcophagi with welters® stone and granite memorial systems including the new Book Memorial



welters® Specialist Mausolea Charging Bier for interment services - part of welters® continuous care programme



welters® Modular Interment Units support the development of unique, varied and attractive Mausolea - creating convex and concave interacting curvature and combining front and side charging opportunities whilst encouraging embellishment with columns, buttresses, pediments, granite and stainless steel features

**Procurement officers are requested to submit all bereavement services requisition requirement to [admin@welters-worldwide.com](mailto:admin@welters-worldwide.com) for our response to tender requests.**

- Marketing and promotional services
- Maintenance support services
- Training services
- Conception to completion turnkey projects
- Design, Manufacture, Install
- High water table installations
- Fully networked 'back up' support 'around the clock'
- Emergency express burial chamber installation service
- Cemetery acquisition
- New cemetery, cemetery extension and common section re-use design and build
- Shallow grave solution design, manufacture, install
- Installation, construction and drainage
- Landscape design and finishing
- Inscription and support services
- Interment and sealing up procedure services
- Cemetery and facilities management
- Part and fully funded schemes

# The Ultimate Funeral Experience

Inspired Products and Services

Interment and Memorial Specialists



welters® Cemetery Village® Schemes

# welters®

ORGANISATION  
WORLDWIDE

DESIGN AND MANAGEMENT CONSULTANTS  
RESEARCH, DEVELOPMENT AND  
MANUFACTURING

P.O. Box 159 Carlisle, Great Britain CA2 5BG

Sales: +44(0)8702 418240 (national rate)

Admin: +44(0)8702 416422 (national rate)

Fax: +44(0)1228 674959

E-mail: [sales@welters-worldwide.com](mailto:sales@welters-worldwide.com)

Web: [www.welters-worldwide.com](http://www.welters-worldwide.com)



welters® impressive Polygon Tower offers cremated remains interment opportunities in an attractive, eye catching feature. Each niche unit can either be utilised for cremated remains with an inscribed granite or stone tablet or can be used as a keepsake niche with a stainless steel door



welters® Cremation Colonnade- an amalgamation of cremation and keepsake niches, Tree of Life™ Reflective Panels & Portico of Peace® Entrance Arch



welters® Majestic Memorial provides space for 4 sets of cremated remains in welters® bespoke caskets and can be installed in a number of configurations.



All welters® decorative steel features can be memorialised with bespoke inscribed 'clip on' Leaves, Butterflies and Doves

**Procurement officers are requested to submit all bereavement services requisition requirement to [admin@welters-worldwide.com](mailto:admin@welters-worldwide.com) for our response to tender requests.**

- Marketing and promotional services
- Maintenance support services
- Training services
- Conception to completion turnkey projects
- Design, Manufacture, Install
- High water table installations
- Fully networked 'back up' support 'around the clock'
- Emergency express burial chamber installation service
- Cemetery acquisition
- New cemetery, cemetery extension and common section re-use design and build
- Shallow grave solution design, manufacture, install
- Installation, construction and drainage
- Landscape design and finishing
- Inscription and support services
- Interment and sealing up procedure services
- Cemetery and facilities management
- Part and fully funded schemes

# The Ultimate Funeral Experience

Inspired Products and Services

Interment and Memorial Specialists



welters® Cemetery Village® Schemes

# welters®

ORGANISATION  
WORLDWIDE

DESIGN AND MANAGEMENT CONSULTANTS  
RESEARCH, DEVELOPMENT AND  
MANUFACTURING

P.O. Box 159 Carlisle, Great Britain CA2 5BG

Sales: +44(0)8702 418240 (national rate)

Admin: +44(0)8702 416422 (national rate)

Fax: +44(0)1228 674959

E-mail: [sales@welters-worldwide.com](mailto:sales@welters-worldwide.com)

Web: [www.welters-worldwide.com](http://www.welters-worldwide.com)

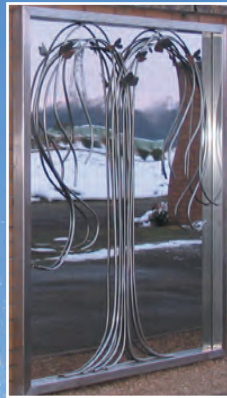

welters® Tree of Life™ and Portico of Peace® features can be memorialised with bespoke inscribed 'clip on' Leaves, Butterflies and Doves



welters® Tree of Life™ Fountain feature and Reflective Panel feature - incorporating welters® signature decorative doves and leaves

welters® Cremation Colonnade - an amalgamation of cremation and keepsake niches, Tree of Life™ Reflective Panels & Portico of Peace® Entrance Arch



Example images of 'clip on' inscribed Leaves, Butterflies and Doves



Introducing welters® Majestic Memorial Mausolea which provides space for 4 sets of cremated remains in welters® bespoke caskets. The system can be installed in a number of configurations and is available in a wide variety of materials and finishes

**Procurement officers are requested to submit all bereavement services requisition requirement to [admin@welters-worldwide.com](mailto:admin@welters-worldwide.com) for our response to tender requests.**

- Marketing and promotional services
- Maintenance support services
- Training services
- Conception to completion turnkey projects
- Design, Manufacture, Install
- High water table installations
- Fully networked 'back up' support 'around the clock'
- Emergency express burial chamber installation service
- Cemetery acquisition
- New cemetery, cemetery extension and common section re-use design and build
- Shallow grave solution design, manufacture, install
- Installation, construction and drainage
- Landscape design and finishing
- Inscription and support services
- Interment and sealing up procedure services
- Cemetery and facilities management
- Part and fully funded schemes

Inspired Products and Services  
Interment and Memorial Specialists

welters® Cemetery Village® Schemes

**welters**  
ORGANISATION  
WORLDWIDE  
DESIGN AND MANAGEMENT CONSULTANTS  
RESEARCH, DEVELOPMENT AND  
MANUFACTURING

[www.welters-worldwide.com](http://www.welters-worldwide.com)



Landscaped Double  
Interment Burial  
Chamber Section



Front and Side  
Charging Convex  
Mausoleum

welters® Cemetery Village™ Schemes with attractive resin bonded multi-flint surfacing



welters® Memorial Stone and Timber Orbs



welters® Chambers with resin bonded surfacing

Visit our website for further information on all of our inspiring products, systems and services which include:

- Marketing and promotional services
- Maintenance support services
- Training services
- Conception to completion turnkey projects
- Design, Manufacture, Install
- High water table installations
- Fully networked 'back up' support 'around the clock'
- Emergency express burial chamber installation service
- Cemetery acquisition
- New cemetery, cemetery extension and common section re-use design and build
- Shallow grave solution design, manufacture, install
- Installation, construction and drainage
- Landscape design and finishing
- Inscription and support services
- Interment and sealing up procedure services
- Cemetery and facilities management
- Part and fully funded schemes

# Interment and Memorial Specialists Inspired Products and Services



welters® Cemetery Village® Schemes

# welters®

ORGANISATION  
WORLDWIDE

DESIGN AND MANAGEMENT CONSULTANTS  
RESEARCH, DEVELOPMENT AND  
MANUFACTURING

[www.welters-worldwide.com](http://www.welters-worldwide.com)

Mausoleum scheme design • Manufacture • Install • Inscription Service • Interment • Maintenance



Front and side charging options



Classic and modern architecture



Family and community styles

Multi-denominational Burial Chamber developments including Muslim, specialist and re-use programmes



Year-round burial provision



Safe 'all-weather' sections



Interment Support Services available

Memorial Orb range of cremated remains niches for up to four interments with express inscription service



Stone Memorial Orbs



Granite Celestial Memorial Orbs



Woodland Memorial Orbs

Visit our website for further information on all of our inspiring products, systems and services which include:

- Marketing and promotional services
- Maintenance support services
- Training services
- Conception to completion turnkey projects
- Design, Manufacture, Install
- High water tablet installations
- Fully networked 'back up' support 'around the clock'
- Emergency express burial chamber installation service
- Cemetery acquisition
- New cemetery, cemetery extension and common section re-use design and build
- Shallow grave solution design, manufacture, install
- Installation, construction and drainage
- Landscape design and finishing
- Inscription and support services
- Interment and sealing up procedure services
- Cemetery and facilities management
- Part and fully funded schemes